

PUSHING LIMITS
ADRENALINE
CHALLENGES
FAMILY MUD
PERFORMANCE
WE'RE FARMING
BUILT HUNTING
FOR ADVENTURE
THIS HARD WORK

**WE'RE
BUILT
FOR
THIS**



OUTLANDER



RENEGADE



CAN-AM ACCESSORIES: THE PERFECT FIT

ENHANCE & EXTEND YOUR OFF-ROAD EXPERIENCE WITH ACCESSORIES BUILT BY CAN-AM FOR CAN-AM.

Wherever you're going, and whatever you're doing, Can-Am Off-Road accessories can help get you there and get it done – faster and more efficiently. High-quality, innovative accessories that work right, fit right and feel right because they're developed or approved by Can-Am for Can-Am.

QUALITY FIRST.

The best off-road accessories are here for a reason: you. High-performance engineering and hard-fought lessons drive the design of everything we do—from our vehicles to the oil they run on.

RUGGED RELIABILITY.

Why do we guarantee Genuine Can-Am accessories for an entire year? Because we can. Install them yourself or at an authorized dealer and immediately upgrade your off-road vehicle without worry.

STYLE & VISION.

Our designers work on both vehicles and accessories, meaning our accessories lineup performs perfectly and looks as great as the Can-AMs they've been designed for.

BRP LIMITED WARRANTY*

FOR NEW PARTS, ACCESSORIES AND RIDING GEAR.

2 YEARS LIMITED WARRANTY**

- GENUINE CAN-AM PARTS & ACCESSORIES INSTALLED BY YOU OR YOUR AUTHORIZED BRP DEALER
- CO-BRANDED PRODUCTS SOLD THROUGH BRP¹
- RIDING GEAR

4 YEARS LIMITED WARRANTY**

- HELMETS

*Use other than which the product is designed for will void the product lifetime warranty. **Applies only to BRP-made products or co-branded products made by accredited BRP partners (Lonestar Racing for Can-Am, DragonFire for Can-Am, S3 for Can-Am, Beard Seats for Can-Am, Baja Designs for Can-Am, etc.). Purchased at an authorized BRP dealership / distributor or on a BRP-authorized online store. Other exclusions may apply, see complete limited warranty or contact your Can-Am off-road authorized dealer. ¹Includes only BRP-approved aftermarket products and products made by currently accredited BRP partners. **Unless otherwise stipulated or required by law. This limited warranty does not apply to factory installed accessories. This limited warranty does not apply on Evinrude parts and accessories. This limited warranty is effective as of March 1st, 2016.

© 2018 Bombardier Recreational Products Inc. (BRP). All rights reserved. ®, ™ and the BRP logo are trademarks of BRP or its affiliates. CARLISLE is a trademark of Carlisle Companies. CHAMUDE and HIPORA are registered trademarks of Kolon Industries, Inc. CLARINO is a trademark of Kuraray Co. Ltd. COOLMAX and THERMOLITE are registered trademarks of INVISTA for durable fabrics. DRIFRELEASE is a registered trademark of Optimer Inc. FOX is a registered trademark of Fox Racing Canada. GARMIN and MONTANA are registered trademarks of Garmin Ltd. iPod is a registered trademark of Apple Inc. KOLPIN, SUN BOOT and IMPACT are registered trademarks of Kolpin Powersports Inc. KYB is a registered trademark of Kayaba. MicroSD is a registered trademark of SD Card Association. Mud Lite XTR and SS312 are trademarks of TIP Tires. NEXT G-1 VISTA is a trademark of Next Camo, LLC. NGK is a registered trademark of NGK Spark Plugs, Ltd. PRIMALOFT GOLD and PRIMALOFT BLACK are registered trademarks of Albany International Corp. SUPERWINCH and S SUPERWINCH (design) are registered trademarks of Superwinch LLC. TEFLON, TEFLON HT and KEVLAR are trademarks of E. I. DuPont de Nemours & Co. TWINAIR is a trademark of Twin Air USA. UNI is a trademark of UNIFILTER Inc. VELCRO is a registered trademark of Velcro Industries. WARN is a trademark of Warn Industries Inc. YUASA is a registered trademark of YUASA Batteries Inc. ZILLA and BIGHORN 2.0 are trademarks of Maxxis. SCOTT is a trademark of Scott Sports SA. The following trademarks are the property of their respective owners: BLUETOOTH, CREE, DURO, DWT, HELLA, ITP, KENDA, MOSSY OAK, RAM, SUR LAST, VISION, XPS and YOSHIMURA. DRAGONFIRE is a trademark of KRANSCO. Baja Designs is a registered trademark of Baja Designs Inc. S3 POWERSPORTS is a trademark of S3 Power Sports LLC. Some models depicted herein may include optional equipment. Prices, if shown, are based on Manufacturer Suggested Retail Prices. Dealers may sell for a different price. For Canada & US, taxes are not included. Depending on location, products are distributed by BRP US Inc., Bombardier Recreational Products Inc., BRP European Distribution SA, BRP Finland Oy., BRP Australia Pty Ltd. or BRP Brasil Motorsports LTDA. BRP reserves the right, at any time, to discontinue or change specifications, prices, designs, features, equipment without incurring obligation.

¹Warranty periods may vary per region.

2019

OUTLANDER
RENEGADE

ACCESSORIES

| | | | |
|----|----------------------|----|------------------------------|
| 6 | COMPATIBILITY GUIDE | 38 | WINCHES |
| 10 | CARGO & STORAGE | 41 | HITCHES |
| 16 | WINDSHIELDS | 42 | PERFORMANCE |
| 19 | HANDLEBARS & MIRRORS | 46 | COVERS, DECALS & ADD-ONS |
| 20 | SEAT KITS | 47 | TRACK SYSTEMS |
| 21 | RACKS & HOLDERS | 50 | PLOWS |
| 24 | SKID PLATES | 55 | OUTLANDER 6X6 ACCESSORIES |
| 29 | BUMPERS & GUARDS | | |
| 34 | LIGHTS & ELECTRICAL | | |

TIRES & RIMS

| | | | |
|----|-------|----|------|
| 59 | TIRES | 60 | RIMS |
|----|-------|----|------|

SPORTSWEAR & RIDING GEAR

| | | | |
|----|-------------------|----|------------------------------|
| 64 | CAN-AM SPORTSWEAR | 69 | COMMUNICATION SYSTEM |
| 66 | MUD GEAR | 70 | GOGGLES / GLOVES / JUNIOR |
| 67 | JERSEYS | 71 | BAGS / SIZING CHART |
| 68 | HELMETS | | |
| 69 | DUST MASKS | | |

PARTS & MAINTENANCE

| | |
|----|----------------------|
| 72 | GENUINE CAN-AM PARTS |
| 78 | OILS & MAINTENANCE |



GOING GLOBAL

This catalog, global in nature, shares BRP's full parts, accessories and clothing product offering. Some products may not be available in your country, due to different climates, local certifications and/or legal requirements. Contact your BRP dealer for local specifics.

CAN-AMOFFROAD.COM



Explore our interactive online catalog. Instantly explore products, videos, large format images and share with friends!



Check out our videos to learn more about our new innovative riding gear and accessories.



Learn about and purchase XPS oils and lubricants.

Visit instructions.brp.com for BRP accessories instruction sheets.

You will find complete installation instructions, part number lists and service kits for repair and maintenance.





WE'RE BUILT FOR HARD WORK

JOB AND JOURNEYS ARE EASIER WHEN SOMEONE'S GOT YOUR BACK: WE ENGINEER UTILITY UPGRADES TO WORK SEAMLESSLY AND TIRELESSLY WITH YOUR OUTLANDER.



OUTLANDER

- 15 LinQ HEAVY-DUTY BASKET
- 15 LinQ LOW PROFILE BASKET
- 31 XT FRONT & REAR BUMPERS
- 32 EXTREME FRONT BUMPER
- 39 CAN-AM TERRA 35 WINCH BY SUPERWINCH



WE'RE BUILT FOR THE TRAIL AHEAD

THE ULTIMATE TRAIL ACCESSORIES DEVELOPED AND TESTED TO LEAD YOU FARTHER WITH PROVEN RELIABILITY AND USEFUL COMFORT FOR LONG RIDES.



OUTLANDER MAX

- 13 LinQ 32 GAL (124L) TRUNK BOX FOR OUTLANDER MAX
- 13 LinQ 32 GAL (124L) TRUNK BOX PANELS
- 17 DELUXE FAIRING
- 17 HIGH WINDSHIELD FOR DELUXE FAIRING
- 17 DELUXE MIRROR KIT
- 33 FENDER FLARES
- 34 HEATED HAND GRIPS & THROTTLE COMBO
- 36 BAJA DESIGNS HIGH BEAM KIT



WE'RE BUILT FOR 40 BELOW

VERSATILE COLD-WEATHER CAPABILITY TO BE EXPERIENCED—AND EVEN ENJOYED—WITH THE APACHE TRACK SYSTEM AND CAN-AM PROMOUNT PLOW KIT.



OUTLANDER MAX

- 18 HIGH WINDSHIELD KIT
- 34 HEATED GRIPS & THUMB THROTTLE COMBO
- 39 WARN PROVANTAGE 3000 WINCH
- 49 APACHE 360 LT TRACK SYSTEM
- 49 APACHE 360 LT MOUNTING KIT
- 51 CAN-AM PROMOUNT FLEX2 60" (152 CM) BLADE
- 53 CAN-AM PROMOUNT PUSH FRAME EXTENSION
- 53 CAN-AM PROMOUNT PUSH FRAME WITH QUICK-ATTACH SYSTEM
- 53 CAN-AM PROMOUNT MOUNTING PLATE
- 54 CAN-AM PROMOUNT BLADE EXTENSIONS
- 54 CAN-AM PROMOUNT DRIFT CUTTERS



WE'RE BUILT FOR HUNTING

YOUR PERFECT HUNTING RIG IS WITHIN REACH—IT'S JUST A MATTER OF OUTFITTING IT TO YOUR NEEDS. THE OUTLANDER ADAPTS QUICKLY BETWEEN JOB AND WEEKEND USE AND MAKES SHORT WORK OF BRINGING GAME HOME.



OUTLANDER

For the international market, the Squad Green color is only available on the Outlander 570 PRO.

- 11 LinQ PREMIUM STORAGE BAG BY OGIO
- 15 LinQ LOW PROFILE BASKET
- 18 LOW WINDSHIELD KIT
- 23 GUN BOOT 6.0 IMPACT BY KOLPIN
- 23 GUN BOOT RACK
- 31 XT FRONT & REAR BUMPERS
- 36 RAM LED SPOTLIGHT
- 39 WARN PROVANTAGE 3000 WINCH



ATV ACCESSORY COMPATIBILITY GUIDE

**WE'VE MADE THINGS
SUPER SIMPLE.**

Determine your **MODEL YEAR**, find your **MODEL** and **ENGINE CONFIGURATION**, and that'll reveal your **PLATFORM CODE**. This code will let you know at a glance if the accessory is compatible with your vehicle.

EXAMPLE

CAN-AM PROMOUNT MOUNTING PLATE

- Required to install the Can-Am ProMount Push Frame with Quick-Attach System.
- Mounting plate precision-designed to stay on year round without compromising ground clearance.

G2, G2L, G2S
715004338



| MODEL YEAR | MODEL | ENGINE CONFIGURATION | PLATFORM CODE |
|-------------|---------------|----------------------|---------------|
| 2013 | Outlander | 400 | G1 |
| | Outlander | 500, 650, 800, 1000 | G2 |
| | Outlander MAX | 400 | G1 |
| | Outlander MAX | 500, 650, 800, 1000 | G2 |
| | Renegade | 500, 800, 1000 | G2S |



| | | | |
|-------------|---------------|---------------------|------------|
| 2014 | Outlander | 400 | G1 |
| | Outlander | 500, 650, 800, 1000 | G2 |
| | Outlander MAX | 400 | G1 |
| | Outlander MAX | 500, 650, 800, 1000 | G2 |
| | Renegade | 500, 800, 1000 | G2S |



FOR G1 ACCESSORIES, REFER TO YOUR LOCAL DEALER.

| MODEL YEAR | MODEL | ENGINE CONFIGURATION | PLATFORM CODE |
|-------------|-----------------|----------------------|---------------|
| 2015 | Outlander L | 450, 500 | G2L |
| | Outlander | 500, 650, 800, 1000 | G2 |
| | Outlander L MAX | 450, 500 | G2L |
| | Outlander MAX | 500, 650, 800, 1000 | G2 |
| | 6x6 | 650, 1000 | G2 |
| | Renegade | 500, 800, 1000 | G2S |



| | | | |
|-------------|-----------------|---------------------|------------|
| 2016 | Outlander L | 450, 570 | G2L |
| | Outlander | 570, 650, 850, 1000 | G2 |
| | Outlander L MAX | 450, 570 | G2L |
| | Outlander MAX | 570, 650, 850, 1000 | G2 |
| | 6x6 | 650, 1000 | G2 |
| | Renegade | 570, 850, 1000 | G2S |



| | | | |
|-------------|---------------|----------------|------------|
| 2017 | Outlander | 450, 570 | G2L |
| | Outlander | 650, 850, 1000 | G2 |
| | Outlander MAX | 450, 570 | G2L |
| | Outlander MAX | 650, 850, 1000 | G2 |
| | 6x6 | 650, 1000 | G2 |
| | Renegade | 570, 850, 1000 | G2S |



| | | | |
|-------------|---------------|----------------|------------|
| 2018 | Outlander | 450, 570 | G2L |
| | Outlander | 650, 850, 1000 | G2 |
| | Outlander MAX | 450, 570 | G2L |
| | Outlander MAX | 650, 850, 1000 | G2 |
| | 6x6 | 650, 1000 | G2 |
| | Renegade | 570, 850, 1000 | G2S |



| | | | |
|-------------|---------------|-----------------------|------------|
| 2019 | Outlander | 450, 570 | G2L |
| | Outlander | 650, 850, 1000, 1000R | G2 |
| | Outlander MAX | 450, 570 | G2L |
| | Outlander MAX | 650, 850, 1000, 1000R | G2 |
| | 6x6 | 650, 1000 | G2 |
| | Renegade | 570, 850, 1000, 1000R | G2S |



FOR G1 ACCESSORIES, REFER TO YOUR LOCAL DEALER.

RUGGED. RELIABLE. DURABLE.

ALL **LinQ CARGO OPTIONS**
ATTACH AND RELEASE IN
SECONDS TO ADAPT BETWEEN
WORK AND PLAY



SHOWN:
LinQ 23 GAL (86L) TRUNK BOX
LinQ 11.5 GAL (43L) AUDIO CARGO BOX



SHOWN:
LinQ 32 GAL (124L) TRUNK BOX



THE ULTIMATE RUGGED COOLER

LinQ 8 GAL (30L) COOLER BOX
SEE P.10



SERIOUS SOUND & STORAGE

LinQ 11.5 GAL (43L) AUDIO CARGO BOX
SEE P.10



SLIM & SLEEK CARGO BOX

LinQ 12 GAL (45L) CARGO BOX
SEE P.11

LIGHTWEIGHT ADDED CAPACITY WITH DIVIDERS

LinQ PREMIUM STORAGE BAG BY OGIO
SEE P.11



ULTIMATE ALL-WEATHER PROTECTION

LinQ 23 GAL (86L) TRUNK BOX
SEE P.12



YOUR LARGEST ITEMS COVERED WITH STYLE

LinQ 32 GAL (124L) TRUNK BOX
SEE P.13



THERE'S A LinQ CARGO OPTION THAT **FITS YOUR NEEDS**

SEE P.10-15 TO DESIGN YOUR OWN CARGO SOLUTION



CATCH THE VIDEO
CAN-AMOFFROAD.COM



UNMATCHED SEMI-RIGID
RUGGED FLEXIBILITY
WITH 3-SECTION LID

OUTLANDER RENEGADE



NEW LinQ 8 GAL (30L) COOLER BOX

- LinQ mounted for easy-on, easy-off installation.
- Rotomolded construction provides exceptional rigidity and durability.
- Premium-quality foam insulation for optimal ice retention.
- Integrated, fully-removable compartment protects food.
- Robust rubber latches keep the cover tightly closed.
- Weather-resistant.
- Convenient drain plug.
- LinQ Luggage Rack (715001734) is required for G2S.

G2 (except 6x6 models), G2S

715004778 • Black

G2 (except 6x6 models), G2S

715004698 • Grey



MUST HAVE



LinQ 11.5 GAL (43L) AUDIO CARGO BOX

- An affordable and quick solution for adding music and storage to your next ride.
- Mounts on/off easily to hold/carry cargo safely and securely.
- The Bluetooth enabled receiver and 6.5" (16.5 cm) speakers are smartly concealed and integrated in the cover.
- Automatic shut-off function protects your battery by turning the system off after 10 minutes of inactivity.
- Backlit control panel perfect for night riding.
- Water-resistant speakers.
- Delivers the best sound quality on the market to sweeten your ride courtesy of a built-in full range high-efficiency amplifier.
- LinQ Base (715002350) is required for G2L.
- LinQ Luggage Rack (715001734) is required for G2S.

G2 (front only for 6x6 & MAX models 2013-2014), G2L, G2S
715003018



MUST HAVE

IT'S A CARGO BOX.
IT'S AN AUDIO RECEIVER &
SPEAKER SYSTEM. IT'S LinQ VERSATILITY
& CAN-AM INNOVATION

OUTLANDER RENEGADE



LinQ 12 GAL (45L) CARGO BOX

- LinQ mounted for easy-on, easy-off installation.
- Holds cargo safely and securely while riding.
- LinQ Base (715002350) is required for G2L.
- LinQ Luggage Rack (715001734) is required for G2S.

G2 (front only for 6x6 & MAX models 2013-2014), G2L, G2S
715003879



NEW LinQ PREMIUM STORAGE BAG BY OGIO

- Tool-less installation and removal thanks to the LinQ System.
- 17.2 Gal (65 L) capacity semi-rigid cargo bag ideal for carrying anything you need on your vehicle.
- Buckle and elastic closure with a rubber seal that protects dust from entering the bag.
- 3-section lid for partial or full access to your bag.
- Inside separators for optimal bag organization.
- LinQ Base (715002350) is required for G2L.
- LinQ Luggage Rack (715001734) is required for G2S.

G2 (except 6x6 models), G2L, G2S

- 715002923 • Black
- 715003248 • Mossy Oak Break-Up Country Camo



INSIDE SEPARATORS FOR
OPTIMAL BAG ORGANIZATION



DURABLE OFF-ROAD CARGO PROTECTION WITH SEAT PADS



OUTLANDER



LinQ 23 GAL (86L) TRUNK BOX

- LinQ mounted for easy-on, easy-off installation.
- Lockable and weather-resistant.
- Holds cargo safely and securely while riding.
- Comfort pads for passenger.
- LinQ Base (715002350) is required for G2L.

G2 (except 6x6 models), G2L, G2S
715004923



LinQ BASE

- Made of polypropylene glass fiber.
- Allows you to install LinQ accessories.
- Sold in pack of 4.

G2L
715002350



LinQ REPLACEMENT PARTS

- Unique mounting fastener usable on any LinQ System accessory.
- Tool-less installation and removal.
- Sold in pairs.

715001707



Some products shown may not be available or homologated in your country. Contact your BRP dealer for local details.

OUTLANDER RENEGADE

LinQ 32 GAL (124L) TRUNK BOXES

Seamless integration with vehicle

- Built from the design stage to specifically match your Can-Am vehicle.
- Totally cohesive design eliminates the need to modify your vehicle in any way*.
- Rear tail light.

Easy quick-attach installation

- Equipped with the LinQ System, the rear trunk box plugs in and out in seconds.
- Instantly transforms your vehicle to suit the need of the moment.

Unparalleled storage

- 32 Gal (124L) load capacity with contiguous unobstructed space to maximize storage room and access to the trunk's interior.

Built tough

- Made of injection-molded polyethylene, double walled in critical areas.

Dust & weather proof

- The fully sealed lid protects your belongings from dust, moisture and the elements.

Lockable

- Built-in lockable barrel.



LinQ 32 GAL (124L) TRUNK BOX

- LinQ Retrofit Adaptor Plate (715001334) is required for G1 models.
- Trunk Box Panels available in many colors to match your vehicle (sold separately).
- LinQ Luggage Rack (715001734) is required for G2S.

G2 (except MAX models & 6x6), G2S
715001747

European Version (EC compliant)
• No rear tail light.
715001748



LinQ 32 GAL (124L) TRUNK BOX FOR OUTLANDER MAX

- Passenger comfort is ensured on active rides as well as longer recreational rides thanks to the ergonomically designed passenger padding comfort-fitted with a portion made of closed cell foam that won't absorb water.
- Very easy to embark even when driver is seated.
- Trunk Box Panels available in many colors to match your vehicle (sold separately).

G2 (MAX models only except 6x6 models)
715001749

EUROPEAN VERSION (EC compliant)
• No rear tail light.
715001750



LinQ 32 GAL (124L) TRUNK BOX PANELS

- Color panels to match the 32 Gal (124L) LinQ Trunk Box to your vehicle.

LinQ 32 Gal (124L) Trunk Boxes

- 715001391 - Black
- 715001392 - Yellow
- 715001395 - Viper Red
- 715002481 - White
- 715002480 - Light Grey
- 715002984 - Octane Blue
- 715002985 - Manta Green
- 715002986 - Can-Am Red

EUROPEAN VERSION (EC compliant)

- No rear tail light
- 715001397 - Black
- 715001398 - Yellow
- 715002482 - Light Grey
- 715002483 - White



CAMO DECALS FOR BLACK TRUNK BOX PANELS

- (Not illustrated)
- Camo pattern perfectly matches your camo vehicle.

- Black LinQ 32 Gal (124L) Trunk Box Panel**
- 715002975 - Mossy Oak Break-Up Country Camo
- 715001683 - Next G-1 Vista Camo

*WARNING: You should never accessorize your Can-Am off-road vehicle with accessories not approved by BRP because your vehicle may no longer meet certain safety and construction standards. This situation could increase the risk of severe injury or death and render your vehicle not legal for use.



PROTECTS
YOUR GEAR.
ORGANIZES
YOUR STORAGE.
MAXIMIZES
VERSATILITY.

OUTLANDER RENEGADE

SOFT STORAGE BAG

- 3-section bag.
- Transport gear in a weatherproof bag.
- 11.8 Gal (45L) capacity soft cargo bag designed with vehicle's rack in mind to maximize potential storage.
- LinQ Luggage Rack (715001734) is required for G2S.

G2, G2L, G2S

715003759 - Black

715001935 - Mossy Oak Break-Up Country Camo



CARGO BAG

- Rugged all-purpose cargo bag with rain cover for additional protection against the elements.
- LinQ Luggage Rack (715001734) is required for G2S.

G2, G2L, G2S

280000539



RAIN COVER
FOR ADDITIONAL
PROTECTION

RENEGADE

STORAGE 2.6 GAL (10L) BAG

- Roll-top dry bag for fully protecting your cargo from the elements.
- Fits in rear compartment of your vehicle.

Fits all

269502121



REAR BAG FOR RENEGADE 4.5 GAL (17L)

- Weatherproof, scratch-resistant, with a molded rubber bottom.
- Tool-less installation and removal.
- With 2 straps that go underneath the rack and click into the front of the bag.
- Requires Rear Aluminum Rack.

G2S

715002391



LinQ SYSTEM MOUNTS
BASKETS IN SECONDS SO YOU
CAN LOAD & GO QUICKER

CATCH THE VIDEO
CAN-AMOFFROAD.COM

OUTLANDER RENEGADE

LinQ
SYSTEM™

LinQ HEAVY-DUTY BASKET

- Made of high-strength, low-alloy steel.
- LinQ mount for easy-on, easy-off installation.
- Can be placed on both front and back racks of vehicle.
- LinQ Base (715002350) is required for G2L.
- LinQ Luggage Rack (715001734) is required for G2S.

G2, G2L (front only for MAX & 6x6 models), G2S

715001215



LinQ
SYSTEM™

LinQ LOW PROFILE BASKET

- Low profile, open basket increases cargo space.
- Perfect for easy access to tools, rope, winch and plow accessories.
- Multiple bungee cord and tie-down anchor points.
- Made of impact-resistant injected polypropylene.
- LinQ Base (715002350) is required for G2L.
- LinQ Luggage Rack (715001734) is required for G2S.

G2, G2L (front only for MAX & 6x6 models), G2S

715004282



CREATE YOUR WIND PROTECTION

This configuration:
DELUXE FAIRING - BLACK
LOW WINDSHIELD
AUXILIARY WINDSHIELD LIGHTING
DELUXE MIRROR KIT



CHOOSE A DELUXE FAIRING AND GET THE WINDSHIELD HEIGHT ACCORDING TO YOUR RIDING STYLE

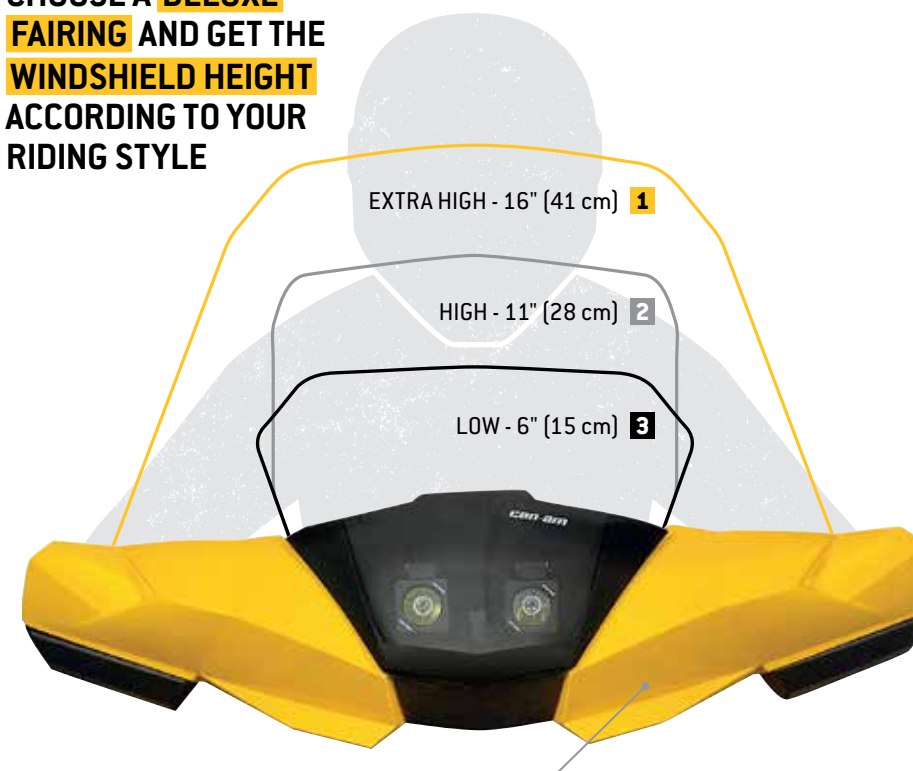

DELUXE FAIRING

- Innovative, richly-featured wind protection.
- Quick tool-less removal once base brackets are mounted on handlebar.
- 2 cup holders.
- GPS-mounting-kit-ready.

G2 (except X mr & 6X6), G2L

- 715000935 - Yellow 2000
- 715001231 - Red Viper

- Optional mirrors and auxiliary lighting.
- Requires low, high or extra high windshield.
- Tapered Handlebar Adaptor Kit is required for vehicles with 1 1/8" (28 mm) tapered aluminum handlebars.

- 715001232 - Black
- 715002479 - Light Grey

CAMO DECALS FOR BLACK DELUXE FAIRING

- Camo pattern perfectly matches your camo vehicle.

Deluxe Fairing

- 715002976 - Mossy Oak Break-Up Country Camo
- 715001684 - Next G-1 Vista Camo

TAPERED HANDLEBAR ADAPTOR KIT

(Not illustrated)

- Required to install Deluxe Fairing on an Outlander X-TP and on any vehicle equipped with 1 1/8" (28 mm) tapered aluminum handlebars.

Deluxe Fairing

715002470

AUXILIARY WINDSHIELD LIGHTING

- 2 premium LED spots for Deluxe Fairing for both increased output and directional lighting.
- 1,800 lumens.
- 2 10W LED Cree light kit.
- Long-range illumination up to 350' (107 m), drawing less than 1 amp per light.

Deluxe Fairing

715003115

DELUXE MIRROR KIT

- Improved mounting system.
- Wide rear view.
- Perfect fit with your Deluxe Fairing and Deluxe Windshield.

Deluxe Fairing

715002353



1 EXTRA HIGH WINDSHIELD

- 16" (41 cm) windshield provides the ultimate protection against the elements while touring.
- For wind protection and winter applications.
- Tool-less installation and replacement.

Deluxe Fairing

715000936

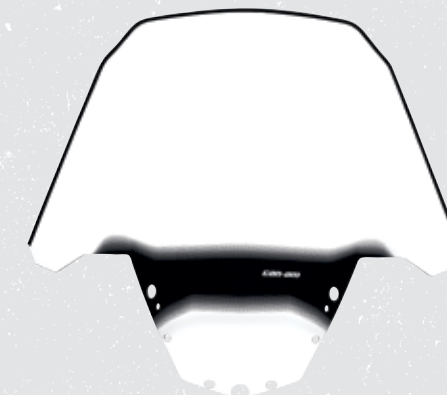

2 HIGH WINDSHIELD

- 11" (28 cm) high, for wind protection and winter applications.
- Tool-less installation and replacement.

Deluxe Fairing

715001211



3 LOW WINDSHIELD

- 6" (15 cm) windshield allows you to keep your vehicle looking sporty while giving you some protection from the elements and the possibility of enjoying directional lighting.
- Tool-less installation and replacement.

Deluxe Fairing

715001227





WIND-DEFLECTING COMFORT & EYE-CATCHING STYLE

OUTLANDER RENEGADE

WINDSHIELD KITS

- Made of polycarbonate with integrated vent to reduce air turbulence and rumble noise at high speed for a quieter and smoother ride.
- Quick tool-less removal once base brackets are mounted on handlebar.
- Fits straight and tapered handlebars.

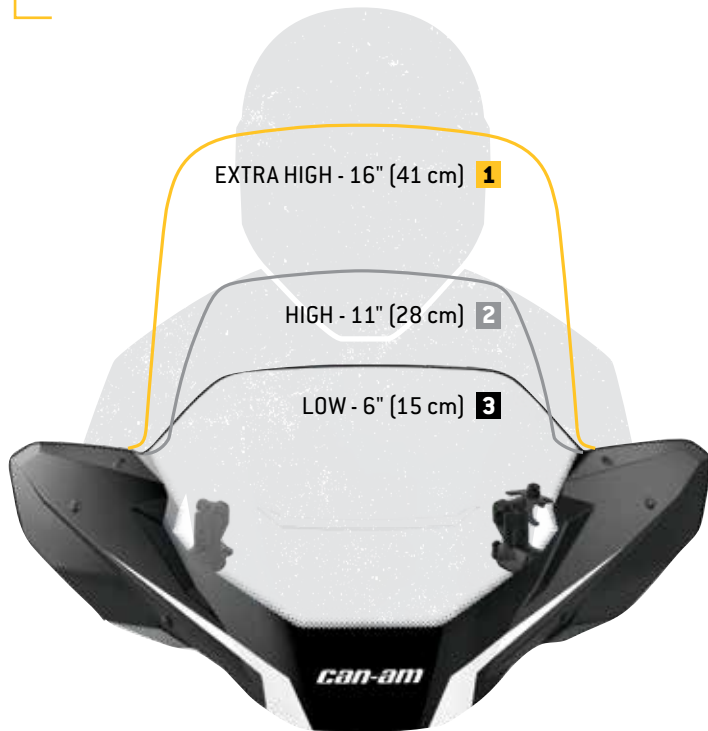

1 NEW EXTRA HIGH WINDSHIELD KIT
 • 16" (41 cm) windshield.
 • For ultimate wind protection and winter applications.
G2, G2L, G2S
 (except X mr models)
 715003023



2 NEW HIGH WINDSHIELD KIT
 • 11" (28 cm) windshield.
 • For wind protection and winter applications.
G2, G2L, G2S
 (except X mr models)
 715003022

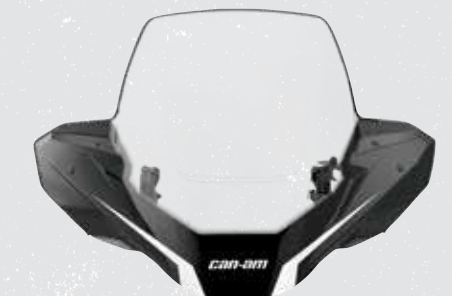

3 NEW LOW WINDSHIELD KIT
 • 6" (15 cm) windshield.
 • Allows you to keep your vehicle looking sporty while giving you some protection from the elements.
G2, G2L, G2S
 (except X mr models)
 715003021



Some products shown may not be available or homologated in your country. Contact your BRP dealer for local details.

OUTLANDER RENEGADE

HANDLEBAR WIND DEFLECTORS

- Rugged injected plastic construction with Can-Am logo.
- Include removable cap for air flow adjustment.
- Mounting kit sold separately.

G2, G2L, G2S

- 715000525 - Black / Yellow
- 715000537 - White / Black
- 715001706 - Black / Black
- 715000733 - Yellow / Black
- 715003811 - Can-Am Red / Black
- 715003812 - Manta Green / Black
- 715003813 - Orange / Black
- 715003814 - Octane Blue / Black



PASSENGER WIND DEFLECTORS

- These wind deflectors fit on the passenger handles and provide greater comfort while riding.
- Easy to install and remove.

G2 and G2L (MAX models only)
 715001669



FULL WRAP ALUMINUM MOUNTING KIT

- Lightweight black die cast aluminum construction.
- Includes complete hardware.
- Handlebar wind deflectors sold separately.

G2, G2L, G2S

715001378



SHORT ALUMINUM MOUNTING KIT

- Lightweight black die cast aluminum construction.
- Includes complete hardware.
- Handlebar wind deflectors sold separately.

G2, G2L, G2S

715001379



MIRROR KIT FOR HANDLEBAR WIND DEFLECTORS

- Do not fit with Full Wrap Aluminum Mounting Kit (715001378).
- Sold in pairs.

Handlebar Wind Deflectors
 860200080



ALUMINUM TAPERED HANDLEBAR

- 7/8" - 1 1/8" (22 mm - 28 mm) tapered handlebar made of 6061-T6 aluminum.
- Includes all hardware, center steering foam and cover.

G2, G2L, G2S

715000550



XT HANDLEBAR PROTECTOR KIT

- Not compatible with Mud Strap (715003053).

G2, G2L

703100352



MIRRORS

- True vision surface 5" x 3" (13 cm x 8 cm).
- Matte finish.
- Stem includes 3/8" (10 mm) thread.

Left - 3/8" (10 mm)

- Bracket (715000190) is required for installation on DS 450.
- Bracket not required for installation on Outlander and Renegade.

709400523

Right - 3/8" (10 mm)

- Bracket (715000190) required except for vehicles with right hand break.

709400523





OUTLANDER

DRIVER BACKREST

- Provides the rider's back with that extra support that makes riding that extra mile way more comfortable.
- Adjusts horizontally to match the driver's height and preference.
- Mounts and locks in firmly onto the vehicle.

G2 (except 6x6 & MAX models)
715003940

G2 and G2L (MAX models only, except 6x6 models)
715003942

G2L (except MAX models)
715003941

DRIVER BACKREST DELIVERS EXTRA SUPPORT SO YOU CAN COVER EXTRA MILES



OUTLANDER MAX PASSENGER SEAT KIT

- Perfect to replace used or damaged passenger seat.

G2 2015 and up, G2L (MAX models only)
715002373



Some products shown may not be available or homologated in your country. Contact your BRP dealer for local details.



LinQ RACK EXTENSIONS EASILY RAISE THE BAR FOR DIFFERENT LOADS

CATCH THE VIDEO
CAN-AMOFFROAD.COM

OUTLANDER RENEGADE

LinQ SYSTEM™ RACK EXTENSIONS

- Fits front or rear.
- Strong and durable.

- Helps keep cargo securely in place.
- Easy and tool-less installation thanks to the LinQ System.

- Anti-corrosion coating with durable powder coat finish.

- LinQ Luggage Rack (715001734) is required for G2S.

LinQ 4" (10 CM) RACK EXTENSION

G2, G2S
 ■ 715001711 - Silver
 ■ 715001665 - Black



LinQ 6" (15 CM) RACK EXTENSION

G2, G2S
 ■ 715001712 - Silver
 ■ 715001671 - Black





OUTLANDER

RACK EXTENSIONS

- Fits front or rear.
- Made of carbon steel.
- Provides tie-down points to secure cargo on racks.
- Easy installation on tubular rack.
- Anti-corrosion coating with durable powder coat finish.

5" (13 CM) RACK EXTENSION

G2L
715001913



8" (20 CM) RACK EXTENSION

G2L
715001914



RENEGADE



LinQ LUGGAGE RACK

- Bolt-on rack.
- Enables use of LinQ mounted accessories on the G2S.

G2S (except X mr models)
715001734



BOLT-ON RACK QUICKLY & EASILY LETS YOU ADD LinQ MOUNTED ACCESSORIES ONTO YOUR RENEGADE

REAR ALUMINUM RACK

- 30 lb (14 kg) capacity.
- Compact, lightweight aluminum construction.
- Engraved Can-Am logo.
- Stamped 5052 aluminum center plate.
- Easy to install.

G2S
715001360



OUTLANDER

GUN BOOT RACK

- Made of steel.
- Designed for the tubular rack.
- For use with Gun Boot 6.0 Impact by Kolpin.
- Can be mounted to either side of the vehicle.

G2L (except MAX models)
715001918

G2L (MAX models only)
715001919

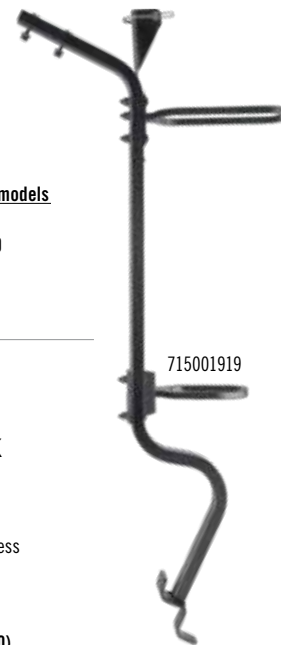

715001919



LinQ GUN BOOT RACK

- (Not illustrated)
- This lightweight Gun Boot Rack can be mounted on either side of your Outlander using the tool-less LinQ System.
- For use with Gun Boot 6.0 Impact by Kolpin.

G2 (except MAX, 6X6 & X mr 1000)
715002112 • Black

G2 (MAX & X mr 1000 models only)
715002113 • Black

GUN BOOT 6.0 IMPACT[†] BY KOLPIN[†]

- Extra room for pistol-grip-type weapons and small bipods.
- Easily fits firearms up to 51" (130 cm) in total length.
- Provides ample room for 2 3/8" (60 mm) scopes.
- Hatchback design allows easy access.
- Ergonomically designed handle and molded attachment points for sling.

G2, G2L
715001419

- Snap-close cover with locking capability.
- Designed to accommodate left and right hand bolt-action rifles and shotguns.
- Includes removable, shock absorbing foam and nylon impact liner for superior interior protection.
- Requires appropriate mounting kit for installation.



MULTI-FIT HOLDER

- Open u-shaped bracket for carrying tools (shovel, axe) and hunting weapons (rifle, bow) that are safely secured, but easily accessible.
- Easy installation on tubular rack, extension racks, basket or bumpers.
- For G2, the LinQ Rack Extension is required.
- Sold in pairs.

G2, G2L
Single
715002354

G2, G2L
Double
715001945



OUTLANDER RENEGADE



LinQ MOUNTED GEAR GRIPS BY KOLPIN

- (Not illustrated)
- Same features as Gear Grip by Kolpin (715001421).
- Make transporting your tools a snap by combining the Gear Grips with the LinQ System.
- 360° orientation.
- LinQ Luggage Rack (715001734) is required for G2S.

G2, G2S
715001421

GEAR GRIPS BY KOLPIN

- Durable, flexible grips cushion and protect while providing a custom fit for a variety of items from 1" to 4" (2.5 cm to 10 cm) in diameter.
- Heavy-duty design for carrying bows, fishing poles, rakes, farm tools and more.
- Quick-release button opens grip quickly for easy access to gear.
- Heavy-duty base system built for the toughest adventures.
- Easy installation on tubular racks, extension racks, brackets or bumpers.
- Sold in pairs.

G2L
715001421



LinQ TOOL HOLDER

- Ultra-versatile tool holder.
- Convenient swivel-latch allows tools to be stored in any orientation.
- LinQ Luggage Rack (715001734) is required for G2S.
- Sold in pairs.

G2, G2S
715003059



Some products shown may not be available or homologated in your country. Contact your BRP dealer for local details.

OUTLANDER RENEGADE

HMWPE SKID PLATES

Our Plastic Plates glide smoothly and silently over obstacles, offering great protection in rough terrain. Made of 1/4" (6 mm) thick abrasion-resistant thermoformed High Molecular Weight Polyethylene (HMWPE). Lighter than aluminum. Superior stress crack resistance. High impact strength.

OFFER YOUR OUTLANDER OR RENEGADE THE FULL PROTECTION KIT OR GET THEM INDIVIDUALLY

FIND YOUR MODEL YEAR AND PLATFORM



| | G2 | | | | | G2L | | G2S | | |
|--|--|--------------------------------------|--|-----------------------------------|---------------------------------------|------------------------------|---------------------|-----------------|------------------|-------------|
| | 2016 & PRIOR MODELS (EXCEPT MAX MODELS & X MR 1000R) | 2016 & PRIOR MAX & X MR 1000R MODELS | 2017-2018 MODELS (EXCEPT MAX & X MR 1000R) | 2017-2018 MAX & X MR 1000R MODELS | 2019 MODELS (EXCEPT MAX & X MR 1000R) | 2019 MAX & X MR 1000R MODELS | (EXCEPT MAX MODELS) | MAX MODELS ONLY | 2017-2018 MODELS | 2019 MODELS |
| HMWPE SKID PLATE PROTECTION KIT | 715004214 | 715004215 | 715004209 | 715004210 | 715004806 | 715004807 | 715004211 | 715004212 | 715004213 | 715004809 |
| INDIVIDUAL HMWPE SKID PLATES | | | | | | | | | | |
| 1 A-ARM PROTECTORS • Protect CV joints and rubber boots. • Include water and mud drainage holes. • Sold in pairs. | 715002924 | 715002924 | 715002924 | 715002924 | 715004822 | 715004822 | 715002924 | 715002924 | 715002924 | 715004822 |
| 2 UNDERBELLY PLATES • Include Front Skid Plate, Central Skid Plate, Footwell Protector Plates and Rear Skid Plate. • Allow access to oil drain plug. • Include water and mud drainage holes. | 715002926 | 715002927 | 715002926 | 715002927 | 715002926 | 715002927 | 715002928 | 715002929 | 715002974 | 715002974 |
| 3 TRAILING ARM PROTECTORS • Include water and mud drainage holes. • Sold in pairs. | 715002925 | 715002925 | 715003466 | 715003466 | 715004823 | 715004823 | 715003466 | 715003466 | 715003466 | 715004823 |
| PLASTIC SKID PLATES | | | | | | | | | | |
| FRONT AND CENTRAL PLASTIC SKID PLATES (Not illustrated) • Designed to protect frame and engine from rough terrain conditions. • Standard on Outlander L DPS® and Outlander L MAX DPS. | - | - | - | - | 715002374 (STD only) | - | - | - | - | - |

*Full HMWPE Skid Plate Protection Kit is available for 6x6 models. See page 58.

OUTLANDER

ALUMINUM SKID PLATES

Our Aluminum Plates are made with high strength 5052 H32 aluminum.
A must-have for rugged terrain.



OFFER YOUR OUTLANDER
THE FULL PROTECTION KIT OR
GET THEM INDIVIDUALLY

FIND YOUR MODEL YEAR AND PLATFORM

| | G2 | | | | | | G2L | | |
|---|--|--------------------------------------|--|-----------------------------------|---------------------------------------|------------------------------|------------------------------|---------------------|-----------------|
| | 2016 & PRIOR MODELS (EXCEPT MAX MODELS & X MR 1000R) | 2016 & PRIOR MAX & X MR 1000R MODELS | 2017-2018 MODELS (EXCEPT MAX & X MR 1000R) | 2017-2018 MAX & X MR 1000R MODELS | 2019 MODELS (EXCEPT MAX & X MR 1000R) | 2019 MAX & X MR 1000R MODELS | 2018 & PRIOR G2L MODELS ONLY | (EXCEPT MAX MODELS) | MAX MODELS ONLY |
| ALUMINUM SKID PLATE PROTECTION KIT | 715002137 | 715002138 | 715004197 | 715004198 | | | | 715004199 | 715004200 |
| INDIVIDUAL ALUMINUM SKID PLATES | | | | | | | | | |
| 1 A-ARM PROTECTORS • 1/8" (3 mm) thick lightweight and durable design. • Add more protection to the CV joints and rubber boots. • Drain holes to release water, mud and debris. • Easy to install. • Replace stock plastic protectors. • Sold in pairs. • Except X mr models. | 715001667 | 715001667 | 715001667 | 715001667 | - | - | 715001667 | 715001667 | 715001667 |
| 2 FRONT SKID PLATE • 3/16" (4,5 mm) thick and die-formed for strength and durability. • Use in conjunction with the central skid plate for full frame protection. | 715000926 | 715000926 | 715000926 | 715000926 | 715000926 | 715000926 | - | 715001906 | 715001906 |
| 3 CENTRAL SKID PLATE • 3/16" (4,5 mm) thick for durability and strength. • Drain holes to release water, mud and debris. • Allows access to oil drain plug. • Must be installed with front skid plate. | 715002078 | 715002078 | 715002078 | 715002078 | 715002078 | 715002078 | - | 715002078 | 715002078 |
| 4 FOOTWELL PROTECTOR PLATES • 1/8" (3 mm) thick lightweight and durable design. • Use in conjunction with the central skid plate. • Drain holes to release water, mud and debris. • Sold in pairs. • Don't fit with 30" Xmr tires. | 715000922 | 715000922 | 715000922 | 715000922 | 715000922 | 715000922 | - | 715000922 | 715000922 |
| 5 TRAILING ARM PROTECTORS • 1/8" (3 mm) thick lightweight and durable design. • Replace stock plastic protectors. • Sold in pairs. | 715001129 | 715001129 | 715003741 | 715003741 | - | - | 715001129 | 715003741 | 715003741 |
| 6 REAR DIFFERENTIAL PROTECTORS • 1/8" (3 mm) thick lightweight and durable design. • Replace stock plastic protector. | 715000920 | 715000920 | 715000920 | 715000920 | 715000920 | 715000920 | - | 715000920 | 715000920 |
| 7 REAR SKID PLATE • 3/16" (4,5 mm) thick for durability and strength. • Must be installed with the central and front skid plates. | 715002028 | 715002029 | 715002028 | 715002029 | 715002028 | 715002029 | - | 715002028 | 715002029 |

Some products shown may not be available or homologated in your country. Contact your BRP dealer for local details.

RENEGADE

ALUMINUM SKID PLATES

Our Aluminum Plates are made with high strength 5052 H32 aluminum. A must-have for rugged terrain.



OFFER YOUR RENEGADE THE FULL PROTECTION KIT OR GET THEM INDIVIDUALLY

FIND YOUR MODEL YEAR AND PLATFORM

| | G2S 2016 & PRIOR | G2S 2017-2018 | G2S 2019 |
|---|------------------|---------------|-----------|
| ALUMINUM SKID PLATE PROTECTION KIT | 715002139 | 715004201 | |
| INDIVIDUAL ALUMINUM SKID PLATES | | | |
| 1 A-ARM PROTECTORS | 715001667 | 715001667 | - |
| 2 FRONT SKID PLATE • 3/16" (4.5 mm) thick and die-formed for strength and durability. • Recessed bolt holes. | 715000925 | 715000925 | 715000925 |
| 3 CENTRAL SKID PLATE • 3/16" (4.5 mm) thick for durability and strength. • Drain holes to release water, mud and debris. • Allows access to oil drain plug. | 715002078 | 715002078 | 715002078 |
| • Standard on Renegade Xc. • Must be installed with Front Skid Plate. | | | |
| 4 FOOTWELL PROTECTOR PLATES • 1/8" (3 mm) thick lightweight and durable design. • Drain holes to release water, mud and debris. | 715001359 | 715001359 | 715001359 |
| • Use in conjunction with Central Skid Plate. • Sold in pairs. | | | |
| 5 TRAILING ARM PROTECTORS • 1/8" (3 mm) thick lightweight and durable design. • Replace stock plastic protectors. | 715001129 | 715003741 | - |
| • Sold in pairs. | | | |
| 6 REAR DIFFERENTIAL PROTECTORS • 1/8" (3 mm) thick lightweight and durable design. | 715000920 | 715000920 | 715000920 |
| • Replace stock plastic protectors. | | | |
| 7 REAR SKID PLATE • 3/16" (4.5 mm) thick for durability and strength. • Must be installed with the central and front skid plates. | 715002028 | 715002028 | 715002028 |

Some products shown may not be available or homologated in your country. Contact your BRP dealer for local details.

DURABILITY SLEEK ENOUGH TO WORK ALONGSIDE YOUR HERD

COMPLETE RANCHER PROTECTION KIT

KIT INCLUDES:

- RANCHER FRONT BUMPER
- RANCHER REAR BUMPER
- BODY SIDE PROTECTOR

SEE P.30



CATCH THE VIDEO
CAN-AMOFFROAD.COM



CATCH THE VIDEO
CAN-AMOFFROAD.COM



OUTLANDER

COMPLETE RANCHER PROTECTION KIT

- These heavy-duty bumpers and fender guard are designed to pull double duty: protect your ATV and anything it comes in contact with, while also enhancing the look of your ATV.
- Made tough and designed to deliver a rugged appearance, together they offer front, rear and full side protection for farmer, rancher and forestry applications.
- Requires Body Side Protector Extensions (715003460) for installation on MAX models.

THIS KIT INCLUDES:

- Rancher Front Bumper (715003461)
 - Rancher Rear Bumper (715003462)
 - Body Side Protector (715003459)
- G2, G2L (except X mr & 6x6 models)**
715003463

RANCHER FRONT BUMPER

- The low front end protection and plates allow you to use your ATV within cattle herds and guard the safety of both the vehicle and the animals.
 - The flat front portion facilitates gently prodding cattle or pushing light objects, e.g. closing a fence.
 - The full frontage coverage extends to provide an extra layer of defense to your headlights and radiator.
 - Inside and outside anti-corrosion coating with durable powder coat finish.
 - Not compatible with track systems, plows and front hitch.
- G2, G2L (except X mr models)**
715003461

RANCHER REAR BUMPER

- Ideal for using your ATV within cattle herds and guard the safety of both the vehicle and the animals.
 - Coverage extends to provide an extra layer of defense to your tail lights.
 - Inside and outside anti-corrosion coating with durable powder coat finish.
 - Not compatible with track systems.
- G2, G2L (except 6x6 models)**
715003462

BODY SIDE PROTECTOR

- Built of durably bold 1.25" (3 cm) diameter steel-tube construction, with inside and outside anti-corrosion coating with durable powder coat finish.
 - XT Front and Rear Bumpers or Rancher Front and Rear Bumpers are required for installation.
 - Requires Body Side Protector Extensions (715003460) for installation on MAX models.
- G2 with XT bumpers 2018 & prior or Rancher bumpers (except X mr & 6x6 models)**
715003459
- G2L with XT bumpers (except X mr models)**
715003614



BODY SIDE PROTECTOR EXTENSIONS

- (Not illustrated)
- This specially designed extension for the Body Side Protector is made specifically to fit and seamlessly integrate the look of Outlander MAX models.

G2 MAX, G2L MAX
715003460

Some products shown may not be available or homologated in your country. Contact your BRP dealer for local details.

OUTLANDER

XT FRONT BUMPER

- Provides additional protection against the elements.
 - Tough and durable, can be added on base Outlander model to convert vehicle into XT model.
 - Standard on XT model.
- G2**
- Large tube construction with textured black finish and plastic corners.
- 715000947

- Large tube construction with textured black finish and metal corners.
- 715004837 **NEW**

AVAILABLE AT YOUR LOCAL DEALERSHIP IN SEPTEMBER 2018.



XT REAR BUMPER

- Provides additional protection against the elements.
 - Tough and durable, can be added on base Outlander model to convert vehicle into XT model.
 - Standard on XT model.
- G2**
- Large tube construction with textured black finish and plastic corners.
- 715000948

- Large tube construction with textured black finish and metal corners.
- 715004920 **NEW**

AVAILABLE AT YOUR LOCAL DEALERSHIP IN SEPTEMBER 2018.



XT FRONT BUMPER

- Large tube construction.
 - Protects vehicle frame against obstacles.
 - Winch compatible.
- G2L**
715001910



XT REAR BUMPER

- Large tube construction.
 - Protects vehicle frame against the obstacles.
- G2L**
715001911





OUTLANDER

EXTREME FRONT BUMPER

- Ultra-sturdy build.
- Enhances front-vehicle protection.
- Compatible with XT Front Bumper.
- Fits the Apache™ 360 Track System (when side panels are removed).
- Not compatible with Front Hitch.

G2
• Not compatible with Front Hitch.
715001286

G2L
715004279



715001286



715004279

RENEGADE

RENEGADE EXTREME FRONT BUMPER

- Enhanced vehicle front protection.
- Required as a mounting point for Radiator Relocator (715001929).

G2S
715002469



**MORE PROTECTION AND
ADDITIONAL STYLE
OUT OF YOUR RENEGADE**

OUTLANDER

FENDER FLARES

- Kit designed to deliver extra protection from dirt and debris, therefore a must if you enjoy riding in the mud.
- Made of injected plastic that hugs your vehicle fenders perfectly.
- Gives vehicle added flair for that rugged cool look.
- Includes front and rear extensions and all mounting hardware.

**G2 (except with 30" tires)
(except 6x6 models)**
715001764

**G2 (with 30" tires)
(except 6x6 models)**
• Standard on G2 X mr 1000R.
715004250

G2L
• Not compatible with T category.
715001909
G2L T category 2015 & up
715004487 **NEW**



NEW BODY SIDE PROTECTOR

- The heavy-duty fender guard designed to pull double duty; protecting your ATV and also enhancing the look of your ATV.
- Made tough and designed to deliver a rugged appearance, this fender guard offers full side protection for farmer, rancher and forestry applications.
- Built of durably bold 1.25" (3 cm) diameter steel-tube construction, with inside and outside anti-corrosion coating with durable powder coat finish.
- New generation XT Front and Rear Bumpers are required for installation.
- Not compatible with Front and Rear Rancher bumpers.

G2 with XT bumpers 2019 (except 6x6 models)
715004940



FENDER FLARE EXTENSIONS

- Block terrain debris from kicking up onto you as you ride or damaging your vehicle thanks to these extra-large Fender Flare Extensions, which also include mud flaps for added protection from mud/snow, especially when riding with track kits.
- Made of High Molecular Weight Polyethylene (HMWPE) for advanced abrasion resistance.
- Include front and rear extensions.

G2 (except 6x6 models)
• Must be used with Fender Flare for G2 (715001764).
715005111

G2L
• Must be used with Fender Flare for G2L (715001909).
715003615



RENEGADE

FENDER FLARES

- Integrated extended Fender Flares for sporty look and full body protection from dirt and water.
- Include front and rear extensions and all mounting hardware.

G2S (except X mr models)
705012695





OUTLANDER RENEGADE

HEATED HAND GRIPS & THROTTLE COMBO

G2, G2L (Wiring Cable (710004567) required for installation), G2S (except 1000R and categorie T models) 715003250



- 1 LED dimmer facilitates reading temperature settings.
- 2 4 temperature settings with individual controls for thumb and grips. Returns to previous heat setting.
- 3 One-touch shutdown.

NEW HEATED GRIPS & THUMB THROTTLE COMBO

• Compatible with Electronic Throttle Control (ETC)
2019 G2, G2S 1000R & 6x6 models only, 2019 T category models
715004815

WIRING CABLE

(Not illustrated)
• Required for installation of Heated Hand Grips & Throttle Combo.
G2L
710004567

Some products shown may not be available or homologated in your country. Contact your BRP dealer for local details.

OUTLANDER RENEGADE

HEATED VISOR OUTLET

- Strategically positioned on vehicle to maintain your agility.
- Optional visor outlet that delivers fog-free riding.
- Quick and easy installation.
- Sold individually.
- Heated Visor not included.

G2, G2L
715001246

NEW USB POWER OUTLET KIT

- Recharges your electronic devices while riding* (smartphone, MP3, heating gear, etc.).
- Dual port USB connectors.
- Plug-and-play kit.
- Simply connect under driver seat and use.

*The power outlet is not capable of recharging all device types while riding.

G2, G2L, G2S
219400510

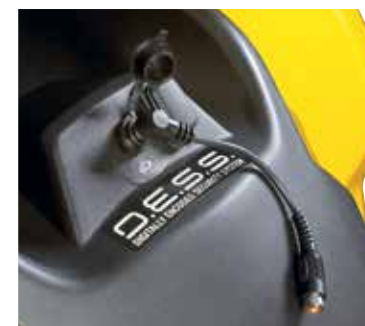

OUTLANDER

HEATED PASSENGER GRIPS & VISOR OUTLET

- Replace your stock passenger handles.
- Dual temperature switch integrated into seat arm for 3-zone heated handles and grips.
- Heated visor outlet integrated into seat arm.

G2, G2L (MAX models only)
715001926
G2 (2013-2014) (MAX models only)
715002116



NEW BLUETOOTH HANDLEBAR SOUNDBAR BY MTX

- Bluetooth speaker with the unbeatable convenience of fingertip control.
- Rugged IP66-rated weather-resistant speaker designed for outdoor use.
- Driven by 150 watts of quality audio power.
- Seamless integration and operation from Bluetooth enabled devices.
- Includes: input, ground and ignition wires, plus auxiliary port and 3.5" connector cable.
- Note: We recommend you use 320 Kbps MP3 - 192-256 Kbps AAC or AIFF, WAV formats to match the potential of the speaker. More compressed formats will probably have degraded sound quality.

G2, G2L, G2S
219400840



CGX3 CAMERA

- 160° wide angle lens.
- Resolution options: from 3MP up to 20MP and VGA.
- Video resolutions available: 2.7K at 30 frames per second (FPS), 720P at 120/60/30 FPS, 1080P at 60/30 FPS and VGA at 240 FPS.
- Record videos in 4K UHD at 24 FPS, 2.7K QHD at 30 FPS and 720P at 120 FPS.
- Memory: Class 10 32GB Micro SD card.
- 2" (5 cm) capacitive touchscreen.
- Li-ion battery capacity of 1050mAh, working time of 1/1.5 hours

9700130090

- and charging time of 3 hours (2 batteries included).
- WiFi function remotely operates up to 10-15 meters with mobile devices and Cyclops app for Android and iOS.
- Waterproof up to 10 meters without a case.
- Features modes such as invert, time lapse, high speed and loop recording, motion detection, capture (while recording a video), burst and anti-sharing.
- Comes with 8 mounting accessories.



CGX3 GIMBAL CAMERA STABILIZER

- (Not illustrated)
- 3-axis full 360-degrees precision: Eliminates shaky video and allows you to easily shoot pro-quality, cinematic-like footage with your Action Camera.
- Built-in Bluetooth 4.0.
- Independent APP to control the gimbal.
- Compatible with iOS 8.0 and Android 4.4 or above.
- Rechargeable battery.
- Rugged, full aluminum alloy.
- 5-way joystick and multi-function button for flexible operations and convenient switch.

9700160090

CGX3 POWER STICK MOUNT

- (Not illustrated)
- 5200mAh of continuous power in your hand, when you need it.
- Rubberized silicone handle for comfort and grip.
- Power indicator light to let the user know when the battery is running low.
- Includes power hand grip, long screw, convert tripod mount, phone clip mount, USB mini cord, USB micro cord and adjustable strap.

9700100090

CGX3 LED LIGHT

- (Not illustrated)
- Wide-Angle 300 Lumen Max. (5500K-6000K) by 3 LEDs.
- Waterproof, attachable light
- Three modes of light: High, Low, Flashing
- Rechargeable battery: 1050mAh.

9700200090

CGX3 SELFIE STICK

- (Not illustrated)
- Easily take photos or record videos with the CGX3 Selfie Stick.
- This selfie stick is made tough for any sport or activity.

9700170090



ALL LED LIGHTS ARE NOT CREATED EQUAL. BAJA DESIGNS LIGHTS ARE COVERED WITH A LIFETIME WARRANTY.

OUTLANDER RENEGADE

BAJA DESIGNS HIGH BEAM KIT

- Thanks to their direct bolt-on and plug-and-play installation right into the original high beam location, upgrading from your stock high beam lights to these powerful Baja Designs Squadron Pro LED Lights becomes child's play.
- Each spot is equipped with 4 Cree LEDs producing 4,900 lumens at 40 watts.
- Driving/Combo light pattern for smooth blend of light for both near field applications and distance.

G2
715004284



NEW MULTI POSITION LIGHT MOUNT KIT

- Multi-position plastic clamps that fit on various tubing sizes: 0.75" to 1.5" (19 mm to 38 mm).
- Required for the installation of the 2" (5 cm) Square LED Lights (2 x 10W).
- Kit includes tube clamp mounts and power cables.

G2 (except X xc), G2L
715004274



2" (5 CM) SQUARE LED LIGHTS (2 X 10 WATTS)

- 2 x 900 lumens 10W LED Cree light kit.
- Long-range illumination up to 350' (107 m), drawing less than 1 amp per light.
- Multi-Position Light Mount Kit is required for installation.
- Not EC compliant.

G2 (except X xc), G2L
715004293



RAM⁺ LED SPOTLIGHT

- 540 lumens LED light (9 Watt) heavy-duty spotlight standard-equipped with 1" (2.5 cm) diameter rubber-coated double ball and socket system.

G2, G2L, G2S
710005423



AUXILIARY WINDSHIELD LIGHTING

- 2 premium LED spots for Deluxe Fairing for both increased output and directional lighting.
- 1,800 lumens.
- 2 x 10W LED Cree light kit.
- Long-range illumination up to 350' (107 m), drawing less than 1 amp per light.

Deluxe fairing
715003115



CENTER CONSOLE DAY LIGHT

- Mountable on top end of center console.
- Enhances look of vehicle.

G2S (except X mr)
715000691



OUTLANDER RENEGADE

NEW BATTERY CHARGER/MAINTAINER

- Fully automatic 3 amp battery charger / maintainer.
- Keeps stored lead-acid batteries charged.
- Charges and maintains small batteries.
- Microprocessor controlled multi-stage charging for added precision, safety and battery life.
- Automatically detects 6 or 12 volt batteries.
- Float mode monitoring automatically maintains optimum battery charge.
- Reverse hook-up protection helps protect battery and charger from damage.
- Hook attachment hangs outside the work area for safety and convenience.
- Press the display button to show the charge progress.
- Energy efficient/eco friendly, meets the highest industry standards for energy efficiency.
- Content: 3 amp battery charger, clamp adapter, DC adapter, 24" (61 cm) fused ring leads harness with weather cap, owner's manual.

715005061



NEW JUMP STARTER

- IPX3 water-resistant and enclosed output ports.
- 4 LED battery indicators for easy read on battery charge level.
- Compact design, will conveniently fit in your backpack, glove box or any other storage compartment.
- Quickly starts vehicles in emergencies.
- Great for powersport vehicles, motorcycles and 4 and 6 cylinder vehicles.
- 2.4A + 1A/5V USB ports for fast charging of all USB devices, including smartphones, MP3 players and tablets.
- Smart cable provides protection against reverse polarity, short circuit, low voltage, high temperature and reverse charging.
- Built-in LED light (3 modes).
- Content: 300CA jump starter, SA858 smart cable clamp, MC-USB to USB charging cable, travel bag, user manual.

715005062



NEW QUICK CONNECT BATTERY CABLE

- (Not illustrated)
- Quickly and easily connect and charge different batteries with your charger.
- Included in the Battery Charger/Maintainer (715005061).
- Sold individually.

715005408

GARMIN⁺ MONTANA⁺ 680T GPS

- Rugged and waterproof, the Montana 680T is element-proof.
- 4-inch dual-orientation, sunlight-readable touchscreen and glove-friendly touchscreen display, to give you vivid colors and high-resolution images.
- 8-megapixel autofocus camera automatically geotags photos.
- Tracks both GPS and GLONASS satellites for improved positioning and typically faster fixes.
- Preloaded TOPO maps, plus 1-year BirdsEye Satellite Imagery subscription.
- 3-axis compass with barometric altimeter.
- Specific GPS cradle included (vehicle mounting kit required).
- Includes a preloaded map for US.

G2, G2L, G2S

715002830

EUROPEAN VERSION

- EC compliant.
- Includes preloaded European recreation map.

715003456



GPS RAM MOUNT FOR HANDLEBAR

- Convenient bracket for installing the Garmin Montana GPS (not included) onto your unit's handlebar.

G2, G2L
715001985





BE READY FOR ANYTHING WITH THE RUGGED HEAVY-DUTY PULLING POWER OF A WINCH

OUTLANDER RENEGADE

WARN[†] PROVANTAGE

- Patented roller disc brake for outstanding control while winching.
- Ergonomic clutch handle.
- Three-stage planetary gear train for smooth, efficient operation.
- All-metal gear housing and gears.

- Fully sealed motor and drive train to keep the elements out.
- Corded remote and mini-rocker control switch with integrated socket.
- Limited lifetime warranty for mechanical components and 3-year warranty for electrical components.

- Mounting Plate (715000927) is required for G2S.
- Wire Harness (715002453) is required for G2L.
- EC compliant.

WARN PROVANTAGE 2500-S WINCH

- Double-powder-coated hawse fairlead.
- Pulling strength capability of 2,500 lb (1,134 kg).
- 50 ft. of 3/16" (15.2 m of 4.8 mm) synthetic rope.
- Mounting Plate (715000927) is required for G2S.
- Wire Harness (715002453) is required for G2L.

G2, G2L, G2S

715003472

WARN PROVANTAGE 3000 WINCH

- Roller fairlead.
- Pulling strength capability of 3,000 lb (1,361 kg).
- 50 ft. of 3/16" (15.2 m of 4.8 mm) wire steel cable.
- Mounting Plate (715000927) is required for G2S.
- Wire Harness (715002453) is required for G2L.

G2, G2L, G2S

715003474

WARN PROVANTAGE 3500-S WINCH

- Double-powder-coated hawse fairlead.
- Pulling strength capability of 3,500 lb (1,588 kg).
- 50 ft. of 3/16" (15.2 m of 4.8 mm) synthetic rope.
- Mounting Plate (715000927) is required for G2S.
- Wire Harness (715002453) is required for G2L.

G2, G2L, G2S

715003473



OUTLANDER

CAN-AM TERRA BY SUPERWINCH[†]

- Heavy-duty 4-way roller fairlead.
- Ergonomic clutch handle.
- Rugged all-steel gears and bushings, provides more torque and longer life.

- Automatic 100% load-holding brake.
- Sealed solenoid for all weather protection.
- Corded 10 ft. (3 m) weather sealed hand-held remote.

- Weather sealed handlebar mounted switch.
- EC compliant.

CAN-AM TERRA 25 WINCH BY SUPERWINCH

- Pulling strength capability of 2,500 lb (1,134 kg).
- 50 ft. of 3/16" (15.2 m of 4.8 mm) wire steel cable.

G2, G2L

715003475



CAN-AM TERRA 35 WINCH BY SUPERWINCH

- Pulling strength capability of 3,500 lb (1,588 kg).
- 50 ft. of 13/64" (15.2 m of 5.2 mm) wire steel cable.

G2, G2L

715003476



Some products shown may not be available or homologated in your country. Contact your BRP dealer for local details.

OUTLANDER RENEGADE

WARN HAWSE FAIRLEAD

- Double-powder-coated construction.
- Required to use the Synthetic Winch Cable (715004254) on Warn winches.
- To be used with synthetic winch cables only.

Warn winches
715004255



WINCH MOUNTING PLATE

- Adds functionality to your Renegade.
- Fits Can-Am winches by Warn.

G2S
715000927



WINCH ACCESSORIES KIT

- Get the most out of your winch.
- Double your pulling power, change your pulling direction and keep your winch in proper working order.
- Includes tree straps, snatch block, shackle and winching gloves.

715002409



WIRELESS REMOTE CONTROL

- The system is quick and easy to install, thanks to a wiring harness with an integrated antenna and all necessary mounting hardware.
- The system allows you to operate your winch from anywhere within a 50' (15.2 m) radius, increasing your recovery options.
- All components are weatherproof.

Warn winches
715002542



ROLLER FAIRLEAD

- Features top, bottom and side rollers for less cable wear and smoother operation from any direction for easier winching.

715000011 • Warn
705204571 • Superwinch



HOOK WITH SAFETY LATCH & STRAP KIT

- Heavy-duty winch-rope hook with stainless steel snap.
- Includes a nylon safety strap.

715003523



WIRED REMOTE CONTROL

- This kit allows winch owners to add the hand-held remote to their winch.
- EC compliant.

For ATVs with handlebar winch remote socket.
710002270

ATVs without the winch remote Socket
• Side panel Remote socket (715003651) is required.
• EC compliant.

710001002
Superwinch winches
710004887



REPLACEMENT WIRE ROPE

- Play it safe, always carry a replacement wire rope.
- 3,500 lb (1,588 kg) pulling strength.

ATV SuperWinch
• 50 ft. of 7/32" (15.2 m of 5.5 mm) wire rope.

705009321
ATV Warn winches
• 50 ft. (15.2 m) aircraft grade steel wire.
• 3/16" (4.8 mm) diameter.
715000047



SYNTHETIC WINCH CABLE

- Easier to manipulate than steel cable.
- Replaces the original cable on any factory installed Warn winch or sold as an accessory by BRP.
- Kit includes synthetic rope and rock guard sleeve.
- Always use with new hawse fairlead (715004255).
- 50 ft. (15.2 m).
- 3,500 lb (1,588 kg) pulling strength.

ATV Warn winches
715004254



WARN REMOTE SOCKET

- (Not illustrated)
• Winch remote socket, located on side panel, is required for wired remote control.

715003651

WINCH WIRE HARNESS

- (Not illustrated)
• Required plug-and-go wiring to install Warn winch only.
• Not required for Can-Am Terra winch.

G2L
715002453

HARDWARE ADAPTER KIT

- (Not illustrated)
• Required to install Warn Winch Kit (715002500, 715002561, 715002499) on 2016 and up models.
• Required to install Can-Am Terra 25 Winch (715002167) and Can-Am Terra 35 Winch (715002057) on G2L 2017 and up models.

715003477



OUTLANDER RENEGADE

FRONT & REAR HITCH DRAWBAR

- Standard on 2" (5 cm) receiver hitch.
- It offers 1,500 lb (680 kg) of towing capacity.
- Hitch ball not included.

G2, G2L, G2S
715000972



European Version

- Drawbar with 2" (50 mm) hitch ball.

705206761 (T Homologated)

OUTLANDER

FRONT RECEIVER HITCH

- Front receiver hitch for Outlander with or without a winch.
- This hitch offers 1,300 lb (590 kg) of towing capacity.
- Allows you to maneuver your trailer easily in tight, confined areas.
- Hitch bar sold separately.
- Not compatible with Extreme Front Bumper and Rancher Bumper.

G2
715000921



RUBBER RECEIVER PLUG

- Rubber cap for 2" (5 cm) hitch receiver.

705204503



REAR HITCH

- E-coat finish.
- Fixed hitch ball mounting bracket.
- Provides fixed mounting point for trailer ball to provide vehicle with towing capabilities.

G2, G2L, G2S (except 6x6 models)
715001925



- This hitch offers 1,300 lb (590 kg) of towing capacity.
- Hitch ball not included.

REAR RECEIVER HITCH

- E-coat finish.
- Does not affect ground clearance.
- Trailer ball not included.
- On 4X4 use, this hitch offers 1,500 lb (680 kg) of towing capacity.
- On 6X6 use, this hitch offers 1654 lb (750 kg) of towing capacity.
- Compliant with European T regulations.

G2S 2012 with 800R or 1000 engines, G2S 2013 & up, G2L
715005186





OUTLANDER

OUTLANDER RADIATOR RELOCATOR KIT

- Relocates radiator to top mount position.
- Prevents cooling performance loss in muddy conditions.
- Uses existing radiator.
- Includes support, hardware and hoses.
- Engineered for easy cooling system bleeding and maintenance.
- Radiator not included.

G2, G2L
715001930



OUTLANDER SNORKEL KIT

- Comprehensive kit.
- Extended air intakes and CVT exhaust.
- CVT outlet integrates into pod cover.
- Must be installed on a vehicle without XT handlebar protector kit.
- Ideal for muddy conditions.
- For 6x6, appropriate gauge support is required for best fit and finish.
- Not compatible with windshields.

G2 2015-2019 only (except 1000R and T category models), G2L
715002392
G2 (2012-2014 only)
715001730



G2 (X mr models only), G2L (X mr models only)

- Raised horn only.
- Provides higher intake.
- For best fit and finish, appropriate gauge support is required.

715002518

X MR TRACTION PLATES

- Provide extra foot grip for driver when riding in extreme mud conditions.
- Help driver to maintain ideal riding position to maximize vehicle traction.
- Made of aluminum.
- Not meant for a passenger.

G2, G2L (MAX models only)
715001752 • Aluminum



FOOTPEG KIT

- Provides maximum integrated grip and more stability during vigorous riding.
- Kick-up end generates added grip during hard cornering.
- Made of aluminum.
- Sold in pairs.

G2, G2L
715001131



RENEGADE

RENEGADE SNORKEL KIT

- Comprehensive kit.
- Extended air intakes and CVT exhaust.
- CVT outlet integrates into pod cover.
- Ideal for muddy conditions.

G2S 2015-2019 only (except 1000R and T category models)
715001928



ADAPTOR KIT

- (Not illustrated)
- Necessary to install the G2S Snorkel Kit (715001928) on 2012 to 2014 models.

G2S (for 2012-2014 models only)
715003122

RENEGADE RADIATOR RELOCATOR KIT

- Relocates radiator to top mount position.
- Prevents cooling performance loss in muddy conditions.
- Uses existing radiator.
- Includes support, hardware and hoses.

G2S
715001929



OUTLANDER RENEGADE

MUD STRAP

- Convenient sturdy grab-handle.
- Lets drivers redistribute their weight for improved traction in demanding conditions.
- Not compatible with XT Handlebar Protector Kit (703100352).

G2, G2L, G2S
715003053



RADIATOR PROTECTOR

- Metal shield which mounts over radiator face, providing protection from stones and branches.

G2, G2S (except G2S with 500 engine)
715001744

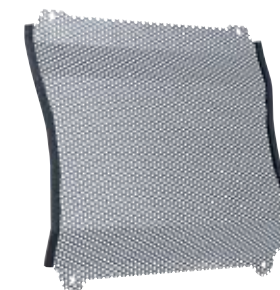



YOSHIMURA GIVES YOU THE EDGE WITH MORE PERFORMANCE & LESS WEIGHT



YOSHIMURA SLIP-ON EXHAUST

- Made from 304-grade stainless steel.
- Better sounding, better looking and lighter than stock muffler.

- USDF/USDA approved spark arrester.
- NON EPA compliant (for racing application only).

- Not EC compliant.
- Fuel injection system tuning not required.

OUTLANDER

YOSHIMURA SLIP-ON EXHAUST

G2 2017 & prior (except 6x6 models)
715001738

G2 2018 & up (except 6x6 models)
715005480



RENEGADE

YOSHIMURA SLIP-ON EXHAUST

G2S 2017 & prior (except 570 engine and X mr models)
715001739

G2S 2018 & up (except 570 engine and X mr models)
715005481



OUTLANDER RENEGADE



FOX SHOCKS

- Engineered for the more aggressive riders.
- Offers increased bump absorption and better roll control.
- Offers a slightly firmer ride than standard kits but remains very useable for all-around use.
- Kit includes 4 shocks and springs.
- Rebuildable.
- Threaded preload adjusters.

G2 2012-2018 (except X mr, XT-P, Limited & 6x6 models), G2 X mr 650 (2012-2018), G2S (Base model with 500 & 570 only), G2L & G2L MAX
715001471



FOX PERFORMANCE SHOCKS 1.5 PODIUM X RC2 HPG

- High-performance front and rear shocks.
- Allow handling to readily adapt to terrain and riding style.
- Easy-adjust dual-speed compression, rebound and preload settings.
- Standard on G2S X xc.

G2 2012-2018 (except X mr, Limited & 6x6), G2 X mr 650 & G2S (Base model & X mr 570 only)
715003201



HEAVY-DUTY SPRINGS

- Heavy-duty springs provide enhanced stiffness.
- Perfect for snow clearing and hauling heavy loads.
- Improves handling and helps prevent accidental overturns.
- Sold in pairs.
- Standard on Outlander Pro and Mossy Oak models.

G2 2012-2018 (Base model, DPS, XT, X mr with 650 engine only & Limited), G2S (Base model with 500 & 570 engines only)

FRONT
715003199



Front

G2 2012-2018 (Base model, DPS, XT & X mr with 650 engine only), G2S (Base model with 500 & 570 engines only)

REAR
715003200



Rear

FRONT SHOCK COVERS

- Feature ventilation holes.
- Offer added protection in rough terrain and weather conditions.
- Sold in pairs.

G2, G2L, G2S
715500301



FOAM AIR FILTER BYTWINAIR†

- Maximizes performance by increasing air flow throughout RPM range.
- Maintenance-friendly, i.e. just wash, re-oil and re-use after riding in severely dusty/muddy environments.

G2, G2S
715001333



Some products shown may not be available or homologated in your country. Contact your BRP dealer for local details.

TRAILERING COVERS

- Heavy-duty canvas made of UV-resistant solution-dyed polyester.
- Inner soft liner protects windshield and colored panels from abrasion.
- All high-abrasion areas are reinforced with a double canvas layer.
- Opening for fuel cap access.
- Weather-resistant trailering cover protects your vehicle during transportation.
- Quick and easy installation.
- Designed to perfectly fit your vehicle with or without Can-Am accessories.

- G2 (except MAX models)**
715001737
- G2 (MAX models only)**
715001736
- G2L (except MAX models)**
715002026
- G2L (MAX models only)**
715002025
- G2S (except X mr models)**
715000683



STORAGE COVERS

- Weather-resistant storage cover.
- For vehicle storage only.
- UV-resistant solution-dyed polyester construction.
- Quick and easy installation.
- Designed to perfectly fit your vehicle with or without Can-Am accessories.

- G2 Xmr (except 1000R), G2L Xmr, G2S, G2S Xmr**
715001720
- G2 MAX, G2L MAX, G2 Xmr 1000**
715001668
- G2L (except MAX models)**
715001916
- G2L (except MAX models)**
715001597 • Mossy Oak Break-Up Country Camo
- G2L (MAX models only)**
715001735 • Mossy Oak Break-Up Country Camo



BOLT-ON[†] RETRACTABLE RATCHETING TIE-DOWNS

- Perfect for transporting your powersport vehicle or securing loads.
- Mounts easily. Bolts on any flat surface (e.g. truck bed or frame).
- 1" x 6' (2.5 cm x 1.8 m) tie-down strap with heavy-duty stitching that delivers a 500 lb (226 kg) working load strength and 1500 lb (680 kg) break strength.
- Convenient retractable push button automatically slackens, spools and stores away strap, while the ratchet mechanism tightens the strap snugly to secure your vehicle or load into place.
- Rubber ratcheting handle provides firm grip, and the hook is vinyl coated to protect whatever surface it hooks into.
- Sold in pairs.

295100737



RATCHET TIE-DOWNS

- 400 lb (181 kg) safe working load.
- 1" x 10' (2.5 cm x 3 m) strap with Sea-Do, Ski-Doo and Can-Am logos.
- Deluxe ratchet with rubber handle.
- Coated S hooks.
- Pack of 2.

860200447 • Black/Grey



FLAG

- Make sure everyone knows what you're riding.
- Perfect for the dunes and new riders.
- 8-foot (2.4 m) length.
- Includes flag mount (715000127).

715000277 • Yellow



FLAG MOUNT

715000127

CUP HOLDER

- Mounts easily to handlebars or racks.

715000121



LOCKABLE GAS TANK CAP

- Protects your fuel.
- Meets EPA requirements.

G2, G2L, G2S
860200387 • Black



LICENSE PLATE BRACKET

- Provides specific area to install license plate.
- Mounts to rear of vehicle.

G2L **G2S**
715002498 715001401



DECAL

- 6" x 12 3/4" (15 cm x 32 cm).

704901483



Some products shown may not be available or homologated in your country. Contact your BRP dealer for local details.



APACHE TRACK SYSTEMS TAKE ON THE TOUGHEST CONDITIONS, YEAR ROUND.

Highly engineered track system provides ultimate traction in harsh conditions for your Can-Am vehicle.

Heavy-duty components ensure reliability and the design offers excellent acceleration, turning, braking and side-hilling performance.

An innovative DPS module ensures speedometer accuracy and optimized steering assist for use with tracks, which make for perfect control and riding ease.

| | MODEL | TRACK MOUNT KIT | TRACK DPS MODULE | TRACKS |
|--------------------|----------------------------|--|---|-----------|
| APACHE 360 | G2, G2S 2018 & prior, G2L | 715004829 | 715005243 | 715005240 |
| | G2, G2S 2019 | 715004795 | 1000R models: 715004707 Everything else: 715005243 | |
| APACHE 360 LT | G2, G2S 2018 & prior, G2L | 715004829 PLUS: 715003063 (adaptor) | 715005243 | 715003064 |
| | G2, G2S 2019 | 715004795 PLUS: 715003063 (adaptor) | 1000R models: 715004707 Everything else: 715005243 | 715005103 |
| | G2 6x6 models 2018 & prior | 715004991 | 715005243 | 715005104 |
| | G2 6x6 models 2019 | 715005105 | | |
| APACHE BACKCOUNTRY | G2, G2S 2018 & prior, G2L | 715004830 | 715005243 | 715003042 |
| | G2, G2S 2019 | 715004796 | 1000R models: 715004707 Everything else: 715005243 | |

AVAILABLE AT YOUR LOCAL DEALERSHIP IN SEPTEMBER 2018.

APACHE BACKCOUNTRY TRACK SYSTEM

Efficient frame and rail design ensures weight is evenly distributed on snow

Aggressive track design with a 2" lug height for maximum traction

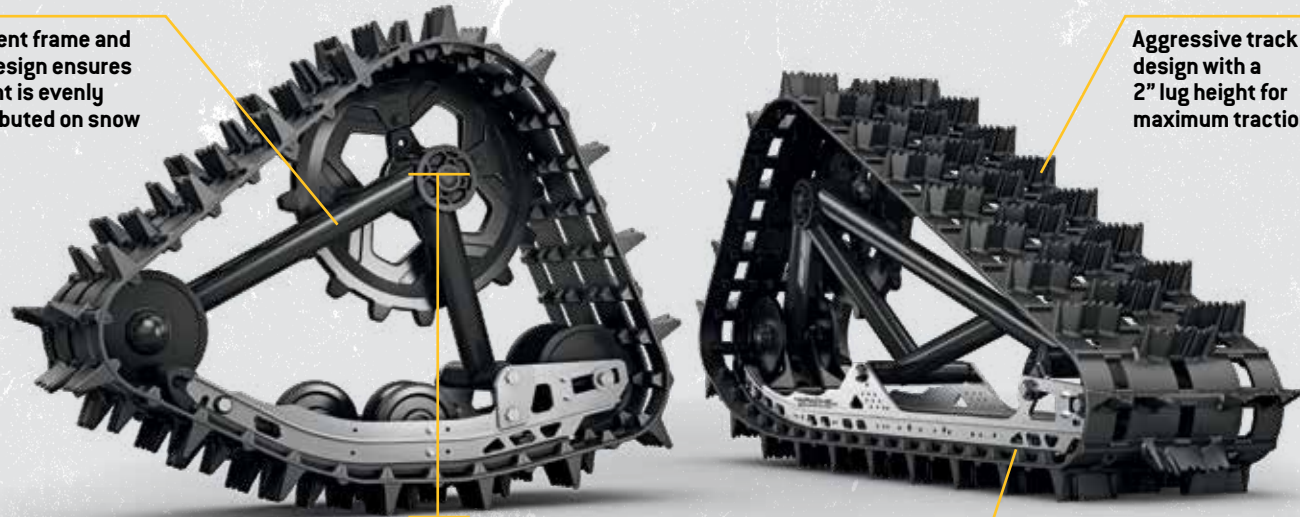

Added ground clearance of 7" (18 cm)

Largest contact patch anywhere: 23% more than the Apache 360 LT

Quick & easy installation

OUTLANDER RENEGADE

APACHE™ BACKCOUNTRY TRACK SYSTEM

- Designed to deliver the best flotation level and deep-snow performance on the market.
- Contact patch is 23% bigger than the Apache 360 LT.
- Impressive added ground clearance of 7" (18 cm), keeps the vehicle out of deep snow.
- Aggressive track design with 2" (5 cm) lug height for maximum traction on snow.
- Apache Backcountry Mounting Kit and engine and CVT air intake pre-filters are required.
- For winter use only.

G2 (except 6x6 models), G2S, G2L
715003042

WINTER TRACKS

Can-Am's new **APACHE BACKCOUNTRY TRACK SYSTEM** is the perfect fusion of BRP's renowned snowmobile and innovative Apache 360 Track System technologies. It delivers the highest ground clearance, the most flotation, and the best deep-snow performance of any ATV track kit on the market today. Period. An efficient frame and rail design ensures weight is spread evenly on snow so you always enjoy higher traction, remarkable acceleration, turning, braking and side-hilling. And it's the only kit available with a 13.5" X 96" [34 cm x 244 cm] front track / 14" X 138" [36 cm x 351 cm] rear track, which adds up to the largest contact patch anywhere.

APACHE BACKCOUNTRY MOUNTING KIT

- (Not illustrated)
- Required for installation of the Apache Backcountry Track System.
- DPS module and pre-filter are required and sold separately.

G2 2018 & prior, G2S 2018 & prior, G2L **G2 2019, G2S 2019**
715004830 715004796

AVAILABLE AT YOUR LOCAL DEALERSHIP IN SEPTEMBER 2018.

IDLER WHEEL KIT

- Reduces drag and rolling resistance.
- Includes 2 wheels, brackets and hardware.
- Add up to 2 kits per rear track.
- Can extend slider life in hardened snow conditions.

Apache Backcountry Track System (rear tracks only)
860201230 - 141 mm



TRACK DPS MODULE

- (Not illustrated)
- An innovative DPS module that ensures speedometer accuracy and optimized steering assist, which make for perfect track control and riding ease.
- Required to install the Apache Track Systems.

G2 2018 & prior, G2 2019 (except 1000R models), G2S 2018 & prior, G2S 2019 (except 1000R models), G2L, 6x6 **G2 2019 (1000R models), G2S 2019 (1000R models)**
715005243 715004707

AVAILABLE AT YOUR LOCAL DEALERSHIP IN SEPTEMBER 2018.

SLIDERS WITH VESPEL[†] INSERTS

- Use DuPont Vespel inserts for less friction.
- Longer life.
- Can be cut to desired length.
- 8 needed per vehicle.
- Sold individually.

Apache Backcountry Track System
503194815



APACHE 360 LT TRACK SYSTEM

Ground surface area is 7 to 9% larger than the Apache 360's



APACHE 360 TRACK SYSTEM

Rubber over molded heavy-duty double bearing wheels and offset wheel spacing reduce friction and vibration while ensuring reliability



Added ground clearance of 4.5" [11.4 cm]

Total ground surface area: 2079.7 in²

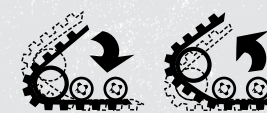

Unique adjustable contact patch system to tackle the toughest year-round conditions



Quick & easy installation

AIR INTAKE PRE-FILTER

- Adds extra protection for your engine in harsh riding conditions.
- Filter blocks particles larger than 0.005".
- Necessary to maintain vehicle warranty when tracks are installed.

G2, G2L, G2S
715004729

CVT AIR INTAKE PRE-FILTER

- Adds extra protection to your engine in harsh riding conditions.
- Helps keep air filter cleaner.
- Filter blocks particles larger than 0.007" (0.19 mm).
- Easy, tool-less installation.
- Necessary to maintain vehicle warranty when tracks are installed.
- Standard on Outlander 650, 850, 1000, 1000R engines & G2L PRO.

715003483



YEAR-ROUND TRACKS

The **360 LT AND APACHE 360 TRACK SYSTEMS** offer a unique adjustable contact patch designed to take on the toughest year-round conditions. Their built-in versatility lets you optimize attack angle for rough terrain or deep-snow operation. Ideal in softer spring thaw conditions, they deliver enhanced ground adhesion, making them a favorite for navigating swamps and bogs.

APACHE 360 LT TRACK SYSTEM

- Multifunctional tracks designed to support heavy loads and to fit on most Can-Am off-road vehicles.
- Extra contact patch adjustment for better performance over rough terrain.
- Contact patch is 7 to 9% bigger than the Apache 360's.
- Average ground clearance increase of 4.5" (11.44 cm).
- 1" (2.5 cm) lugs in the front and 1.25" (3.2 cm) in the back.
- Apache 360 and 360 LT Mounting Kit and engine and CVT air intake pre-filters are required.

G2 (except 6x6 models), G2S 2019
715005103

G2, G2S 2018 & prior (except 6x6 models), G2L
715003064

AVAILABLE AT YOUR LOCAL DEALERSHIP IN SEPTEMBER 2018.

APACHE 360 TRACK SYSTEM

- Multifunctional tracks perfect for any Can-Am ATV.
- Average ground clearance of 16" (41 cm).
- 1" (2.5 cm) lugs in the front and 1.25" (3.2 cm) in the back.
- Apache 360 & 360 LT Mounting Kit and engine and CVT air intake pre-filters are required.

G2 (except 6x6 models), G2L, G2S
715005240

APACHE 360 & 360 LT MOUNTING KIT

- (Not illustrated)
- Required to install Apache 360 & 360 LT Track Systems.
- Requires Apache 360 LT ATV Adaptor (715003063) for installation of the Apache 360 LT Track System.
- DPS module and Pre-Filter not included.

G2 2018 & prior (except 6x6 models), G2S 2018 & prior, G2L
715004829

G2 2019 (except 6x6 models), G2S 2019
715004795

AVAILABLE AT YOUR LOCAL DEALERSHIP IN SEPTEMBER 2018.

APACHE 360 LT ADAPTOR

- (Not illustrated)
- Required to install an Apache 360 LT Track System.
- Apache 360 and 360 LT Mounting Kit also required.

G2 (except 6x6 models), G2S, G2L
715003063

CAN-AM PROMOUNT PLOWS ARE COMPETITIVE, RUGGED AND EFFECTIVE



The all-new Can-Am ProMount Plow Kits are here to take on winter. Whether it's a large commercial lot or a short driveway, this is how to get the job done right. Better, simpler, and with the same Can-Am reliability and durability you expect.

NEW CAN-AM PROMOUNT PLOW SYSTEM

OUTLANDER RENEGADE

CAN-AM PROMOUNT FLEX2 60" (152 CM) PLOW KIT

G2, G2S, G2L
■ 715005202 - Black



KIT INCLUDES:

- Can-Am ProMount Flex2 60" (152 cm) Blade
715004203 - Black
- Can-Am ProMount Push Frame with Quick-Attach System
715004339
Also sold individually on p.53
- Can-Am ProMount Mounting Plate
715004338
Also sold individually on p.53

ALSO SOLD INDIVIDUALLY:

CAN-AM PROMOUNT FLEX2 60" (152 CM) BLADE

- Plow blade made of UHMWPE, flexible and impact absorbing material prevents damaging your plow when accidental impact occurs.
- Blade swivels left or right, 5 positions.
- Large pin designed for easy blade rotation to eliminate dirt and snow buildup at pivot point.
- Blade design provides best snow/dirt roll-off at any angle.
- Compatible with Can-Am ProMount Blade accessories to further enhance plow versatility.
- Clears 54" (137 cm) when plow is fully angled.
- Blade height of 17" (43 cm).

■ 715004203 - Black



CAN-AM PROMOUNT STEEL 54" (137 CM) PLOW KIT

G2, G2L, G2S
■ 715005200 - Black
■ 715005428 - Yellow



KIT INCLUDES:

- Can-Am ProMount Steel 54" (137 cm) Blade
715004472 - Black
or
715005316 - Yellow
- Can-Am ProMount Push Frame with Quick-Attach System
715004339
Also sold individually on p.53
- Can-Am ProMount Mounting Plate
715004338
Also sold individually on p.53

ALSO SOLD INDIVIDUALLY:

CAN-AM PROMOUNT STEEL 54" (137 CM) BLADE

- Plow blade made from 12-gauge steel.
- Replaceable wear blade.
- Blade swivels left or right, 5 positions.
- Large pin designed for easy blade rotation to eliminate dirt and snow buildup at pivot point.
- Blade design provides best snow/dirt roll-off at any angle.
- Compatible with Can-Am ProMount Blade accessories to further enhance plow versatility (except for Can-Am ProMount Steel 54" (137 cm) Blade (715004472)).
- Clears 50" (127 cm) when plow is fully angled.
- Blade height of 14.75" (37 cm).

■ 715004472 - Black
■ 715005316 - Yellow



Some products shown may not be available or homologated in your country. Contact your BRP dealer for local details.



Can-Am ProMount Steel 54" (137 cm) Plow Kit

THERE'S A PLOW FOR EVERY TYPE OF USER AND EVERY TYPE OF USE.

- > Flexible and built to last, the **Can-Am ProMount Flex2 Blade** is the perfect solution for driveways, storefronts and any area that needs clearing quickly and efficiently.
- > Those looking for a range of widths will appreciate the no-nonsense practicality of our **Can-Am ProMount Steel Blades**. Each is designed to put competing plows to shame and both are every bit as tough as the road is long.

OUTLANDER RENEGADE

CAN-AM PROMOUNT STEEL 60" (152 CM) PLOW KIT

- G2, G2S, G2L
- 715005201 - Black
- 715005434 - Yellow



- KIT INCLUDES:**
- Can-Am ProMount Steel 60" (152 cm) Blade 715004202 - Black or 715005317 - Yellow
 - Can-Am ProMount Push Frame with Quick-Attach System 715004339 *Also sold individually on p.53*
 - Can-Am ProMount Mounting Plate 715004338 *Also sold individually on p.53*

- ALSO SOLD INDIVIDUALLY:
- CAN-AM PROMOUNT STEEL 60" (152 CM) BLADE**
- Plow blade made from 12-gauge steel.
 - Replaceable wear blade.
 - Blade swivels left or right, 5 positions.
 - Large pin designed for easy blade rotation to eliminate snow buildup at pivot point.
 - Blade design provides best snow roll-off at any angle.
 - Clears 54" (137 cm) when plow is fully angled.
 - Blade height of 17" (43 cm).
 - Compatible with Can-Am ProMount Blade accessories to further enhance plow versatility.
- 715004202 - Black
 - 715005317 - Yellow



OUTLANDER RENEGADE

BUILT FOR SIMPLICITY. ONE PUSH FRAME & MOUNTING KIT FITS ALL!



CAN-AM PROMOUNT STEEL 66" (168 CM) PLOW KIT

- G2, G2L, G2S
- 715005427 - Black
- 715005435 - Yellow



- KIT INCLUDES:**
- Can-Am ProMount Steel 66" (168 cm) Blade 715004473 - Black or 715005318 - Yellow
 - Can-Am ProMount Push Frame with Quick-Attach System 715004339 *Also sold individually on p.53*
 - Can-Am ProMount Mounting Plate 715004338 *Also sold individually on p.53*

- ALSO SOLD INDIVIDUALLY:
- CAN-AM PROMOUNT STEEL 66" (168 CM) BLADE**
- Plow blade made of UHMWPE, flexible and impact absorbing material prevents damaging your plow when accidental impact occurs.
 - Blade swivels left or right, 5 positions.
 - Large pin designed for easy blade rotation to eliminate dirt and snow buildup at pivot point.
 - Blade design provides best snow/dirt roll-off at any angle.
 - Compatible with Can-Am ProMount Blade accessories to further enhance plow versatility.
 - Clears 60" (152 cm) when plow is fully angled.
 - Blade height of 17" (43 cm).
- 715004473 - Black
 - 715005318 - Yellow



NEW CAN-AM PROMOUNT MOUNTING PLATE & PUSH FRAME

The all-new **Universal Push Frame and Plow Mounting Kit** offers seamless compatibility between our next-generation plastic and steel blades and our ATV models.

- CAN-AM PROMOUNT MOUNTING PLATE**
- Required to install the Can-Am ProMount Push Frame with Quick-Attach System.
 - Mounting plate precision-designed to stay on year round without compromising ground clearance.
- G2, G2L, G2S
715004338



- CAN-AM PROMOUNT PUSH FRAME WITH QUICK-ATTACH SYSTEM**
- Heavy-duty steel tubes designed to withstand the roughest use.
 - Mid-mount carriage provides ultimate push strength and traction.
 - Allows 14" (36 cm) of plow lift.
 - Features a self aligning quick-attach system, an easy foot release pedal and an ergonomic handle for plow angle adjustment.
 - Compatible with all Can-Am ProMount Blades.
 - Plow Roller Fairlead and Plow Limit Switch recommended to extend winch cable lifespan.
 - Can-Am ProMount Mounting Plate required for installation.
- G2, G2L, G2S
715004339



- CAN-AM PROMOUNT PUSH FRAME EXTENSION**
- 12" (30 cm) push frame extension required when plow is installed with Apache Track systems.
- G2, G2L, G2S
715004204



Some products shown may not be available or homologated in your country. Contact your BRP dealer for local details.

PLOW ACCESSORIES

OUTLANDER RENEGADE

NEW CAN-AM PROMOUNT EDGE MARKERS

- Help locate the edges of your plow.
- Height: 24" (60 cm).
- Sold in pairs.

G2, G2L, G2S
715004206

NEW CAN-AM PROMOUNT DRIFT CUTTERS

- Help keep snow in the plow.
- Dimensions: 17" x 13" (43.2 cm x 33 cm).
- Sold in pairs.
- Compatible with Can-Am ProMount Blades with or without blade extensions (except for the Can-Am ProMount Steel 54" (137 cm) Blades).

G2, G2L, G2S
715004207

NEW PLOW LIMIT SWITCH

- (Not illustrated)
- For controlling the cable tension when over raising your plow system.
- Prevents winch, plow push frame and vehicle damage.

G2, G2L, G2S
715004775

NEW CAN-AM PROMOUNT BLADE EXTENSIONS

- These conveniently extend your Can-Am ProMount Blade.
- Add 3" (8 cm) each side.
- Compatible with Can-Am ProMount Blades (except for the Can-Am ProMount Steel 54" (137 cm) Blades).
- Longer Wear Blade can be installed to go over the extra length given by the extensions.

G2, G2L, G2S

■ 715004205 - Black

■ 715005319 - Yellow

NEW PLASTIC WEAR BLADE

- Ideal to prevent leaving marks on your driveway.

G2, G2L, G2S

Can-Am ProMount 54" (137 cm) Plastic Wear Blade

715004480

Can-Am ProMount 60" (152 cm) Plastic Wear Blade

715004481

Can-Am ProMount 66" (168 cm) Plastic Wear Blade

715004482

SYNTHETIC WINCH CABLE FOR PLOWING

- Specially designed for plowing applications.
- 8' (2.4 m) section of durable, extra-strong synthetic rope.
- Stands up to repeated, sharp angle pulls used to lift heavy plow blades.
- Temporarily replace your winch rope for plow season to save wear and tear on wire rope.

715000540



PLOW ROLLER FAIRLEAD

- Larger diameter lower roller reduces wear on wire rope for plow application.
- For use with snow plows.

G2, G2S, G2L
705009222



PULLEY KIT

- Pulley kit to be used in conjunction with the winch when using a snow plow.
- Recommended to increase winch efficiency.
- To be used with the XT Front Bumper.

715000279



REAR TIRE CHAINS

- Improve your traction in mud and snow.
- Sold in pairs.

26" x 10" x 12"
715500218

25" x 10" x 12"
27" x 9" x 14"
715000225



HIGHLY ENGINEERED APACHE 360 LT TRACK SYSTEM PROVIDES ULTIMATE TRACTION IN HARSH CONDITIONS FOR YOUR OUTLANDER 6X6

APACHE 360 LT TRACK SYSTEM

- Exclusively for the Outlander 6x6.
- Enjoy superior acceleration, turning, braking, and side-hilling.
- Reliable heavy-duty build.
- Can-Am designed technology.
- Switch easily between enhanced attack angle or improved flotation.
- For winter use only.
- EC compliant.

G2 (6x6 models only)
715005104

AVAILABLE AT YOUR LOCAL DEALERSHIP IN SEPTEMBER 2018.



NEW APACHE 360 LT MOUNTING KIT

- (Not illustrated)
- Required for installation of the Apache 360 LT Track System.
- Track DPS module and Pre-Filter not included.

G2 (6x6 models 2018 & prior)
715004991
G2 (6x6 models 2019)
715005105

AVAILABLE AT YOUR LOCAL DEALERSHIP IN SEPTEMBER 2018.

NEW TRACK DPS MODULE

- (Not illustrated)
- Innovative DPS module that ensures speedometer accuracy and optimized steering assist, which make for perfect track control and riding ease.
- Required to install the Apache Track Systems.

G2 (6x6 models only)
715005243

AVAILABLE AT YOUR LOCAL DEALERSHIP IN SEPTEMBER 2018.

Some products shown may not be available or homologated in your country. Contact your BRP dealer for local details.

**QUICKLY & SAFELY
CONVERT YOUR BED
TO HAUL TIMBER
FROM THE BUSH**



LOG BARS

- Log bars allow you to convert the cargo bed into a perfect transport space for 4' (120 cm) timber.
- The driver's safety is guaranteed by the protective front screen.

G2 (6x6 models only)

715002486 • Latin America/Asia Pacific
715001987 • Europe



HARD TOP

- The hard top provides a 116 Gal (440L) cargo box.
- Locking secures your belongings.
- The cover raises assisted by gas cylinders.

G2 (6x6 models only)

715002490 • Latin America/Asia Pacific
715002394 • Europe

SIDE WALLS AND TAIL GATE

- Allows for a quick and easy conversion of the cargo bed into a trunk with plenty of room.
- Rotationally molded walls provide extreme durability for hard work - in all conditions.

G2 (6x6 models only)

715002868 • Latin America/Asia Pacific
715001989 • Europe



TAILGATE EXTENSION/DIVIDER

- The sturdy tailgate extension provides a 10" (25 cm) extension to the cargo space.
- Thanks to the longer cargo bed, even large loads pose no problem.
- With the help of LinQ quick locks, the extension also acts as a solid space divider for the cargo bed.

G2 (6x6 models only)

715002488 • Latin America/Asia Pacific
715002017 • Europe



18 GAL (70L) UTILITY BOX

- Wherever you go and whatever you do, this handy 18 Gal (70L) utility box is your mobile storage.
- The lid keeps your equipment safe from the elements in all conditions.
- Slides under the flatbed with handles for easy access.

G2 (6x6 models only)

715002487 • Latin America/Asia Pacific
715001999 • Europe



TARPAULIN

- Fitted to cover all of the items in your cargo box thoroughly.
- Prevents splash from entering cargo box.
- Easily removable for quick access.

G2 (6x6 models only)

715002491 • Latin America/Asia Pacific
715002416 • Europe



FLATBED PROTECTION TUBES

- Bolt-on bumpers for the sides of the 6x6 flatbed.
- Protects the exterior plastic components of the flatbed from rocks, trees and other obstacles when traversing enclosed areas or loading cargo onto the bed.

G2 (6x6 models only)

715002489 • Latin America/Asia Pacific
715002030 • Europe



TAILGATE LIMITER KIT

- 2 L-shape brackets that hold the tailgate open horizontally.
- Keeps tailgate flush with the rest of the flatbed for longer oversized cargo.

G2 (6x6 models only)

715002534 • Latin America/Asia Pacific
715002080 • Europe



STORAGE COVER

(Not illustrated)

- For storage use only.
- Heavy-duty elastic cord around bottom for secure fit.

G2 (6x6 models only)

715002492 • Latin America/Asia Pacific
715002415 • Europe

- 100-denier polyester construction.
- Fits with or without windshield and mirrors.

CARGO BOX NET

- Solid net designed to hook to the bottom of the cargo box for secure and compact confinement of your cargo.

G2 (6x6 models only)

715001371





ENGINEERED TO PROTECT & PRESERVE VEHICLE FRAME, ENGINE & DRIVETRAIN

FULL BODY SKID PLATE

- A full body plastic skid plate (10 mm HDPE) designed to protect the frame and the engine case from rough terrain conditions.
- The plastic allows your ATV to slide easily over stumps and logs.

G2 (6x6 models only)

715002485 - Latin America/ Asia Pacific
860200896 - Europet



REAR WINCH KIT

- The remote-controlled rear winch is a godsend when you want to pull yourself out of a tough spot or move heavy loads.
- Includes a fully-sealed Warn winch and all wiring and hardware needed for an easy and quick installation.
- Pulling strength capability of 3,000 lb (1,361 kg).
- 50 ft. of 3/16" (15.2 m of 4.8 mm) wire steel cable.

G2 (6x6 models only)

715002484



DRIVER BACKREST

- Provides the rider's back with that extra support that makes riding that extra mile way more comfortable.
- Adjusts horizontally to match the driver's height and preference.
- Mounts and locks in firmly onto the vehicle.

G2 (6x6 only)

715003611



ITP TERRACROSS TIRE

- This smooth-riding tire will command every bit of traction from the ground while still managing to float across loose snow, sand and mud.
- Features extreme-duty construction for improved puncture protection, extra-tough rubber compound for increased tread life, and the interlocking tread pattern and wide footprint make it one of the toughest and grippiest radials around.
- Not EC compliant.

G2 XTP, G2 Limited

Front - 26" x 8" x 14"

705401906

Rear - 26" x 10" x 14"

705502421



GROUND-GRIPPING TRACTION MEETS LOOSE MUD MANEUVERABILITY. THE TOUGH TIRE WITH THE SMOOTH RIDE.

NEW ITP CRYPTID TIRE

- Graduated lug height and paddle-like shoulder configuration provide maximum side bite for climbing in and out of the mud without compromising ride comfort on trails and hard pack.
- 6-ply rated.
- 30" x 9" x 14".

G2 X mr 850 & 1000R 2018 & up,

G2S X mr 1000R 2018 & up

705402178 - 30" x 9" x 14"



NEW ITP MEGA MAYHEM

- 1.5" tread depth mud thrower tires.
- Surprisingly smooth ride on hard pack surfaces.
- 6-ply rated.

G2 X mr 570 & 650 2018 & up,

G2S X mr 570 2018 & up

Front

28" x 9" x 12"

705402131

Rear

28" x 11" x 12"

705502645



GORILLA SILVERBACK TIRE

- AT30X9-14 Gorilla Silverback mud tire.
- Sold individually.
- Not EC compliant.

G2 (850 & 1000 models only)

30" x 9" x 14"

705400962



MAXXIS MUDZILLA TIRE

- Not EC compliant.
- **G2 (X mr 570 & 650 models only)**

Front

28" x 8" x 12"

705401391

Rear

28" x 10" x 12"

705501836



ZILLA TIRE BY MAXXIS*

- Sold individually.

Front

27" x 10" x 14"

705401302

Rear

27" x 12" x 14"

705501703



CARLISLE ACT TIRE

G2 (500-1000 XT models only)

Front

26" x 8" x 12"

705401333

705401334 - CE

Rear

26" x 10" x 12"

705501769

705501770 - CE

G2 (400 XT models only)

Front

25" x 8" x 12"

705400606

705400326 - CE

Rear

25" x 11" x 12"

705500933

705500598 - CE



CARLISLE ACT HD TIRE

Front

26" x 8" x 12"

705401736

Rear

26" x 10" x 12"

705502297

CARLISLE BADLANDS A/R TIRE

G2 (500-1000 Base models only)

Front

26" x 8" x 12"

705401331

705401332 - CE

Rear

26" x 10" x 12"

705501767

705501768 - CE



*Consult your operator's guide/owner's manual for proper tire type and rim sizing. Improper tire type and rim selection may affect vehicle handling. Check with your local authorities for proper regulation.

Some products shown may not be available or homologated in your country. Contact your BRP dealer for local details.

CARLISLE TRAIL WOLF TIRE

G2 (400 Base models only)
 Front
 25" x 8" x 12"
 705401625
 705400607 - CE
 Rear
 25" x 11" x 12"
 705502164
 705502165 - CE



ITP HOLESHOT ATR TIRE

G2S
 Front 205/80R12
 25" x 8" x 12"
 705400600
 705400475 - CE
 Rear 270/60R12
 25" x 10" x 12"
 705500926
 705500820 - CE



DURO THRASHER TIRE

DS 90/70
 Front - 19" x 7" x 8"
 V42711DGF00LL
 Rear - 18" x 9.5" x 8"
 V42712DGF010LL



KENDA KLAW MXR TIRE

DS 90 X
 Front - 20" x 6" x 10"
 V42711DGF01HLL
 Rear - 18" x 10.5" x 8"
 V42712DGF01HLL



REAR TIRE CHAINS

• Improve your traction in mud and snow.
 • Sold in pairs.
 26" x 10" x 12"
 25" x 11" x 12"
 715500218
 25" x 10" x 12"
 26" x 9" x 12"
 27" x 9" x 14"
 715000225



KENDA KNARLY TIRE

DS 250
 Front - 22" x 7" x 10" Rear - 20" x 11" x 9"
 S44710RCA000 S42710RCA000



NEW 14" RIM

G2 DPS, G2 XT, G2 MAX Limited, G2 Winter, G2 MAX Winter
 Front - 14" x 6.5" offset = 40 mm Rear - 14" x 8.5" offset = 50 mm
 705402309 - Black and machined 705502770 - Black and machined
 705402222 - Black with clear coat 705502702 - Back with clear coat
 705402307 - Silver with clear coat 705502768 - Silver with clear coat



OUTLANDER X MR RIM

• Cast aluminum rim with trend setting explosive styling so you can ride - and look - like a trailblazer.
 • Front: 14" x 6.5" offset = 10 mm.
ATV (X mr models front and rear wheels)
 ■ 705401848 - Black and machined
 ■ 705401849 - Black



OUTLANDER X MR RIM - ITP-SS212*

• Black with machining and clear coat rim.
 • Matching Cap (705400963), Matching Nuts (250100100).
 • Sold individually.
G2 (X mr models only)
 Front & Rear - 14" x 6"
 705400877 - Black and machined



Note: Matching Nuts - 250100100 Black, 250100082 Chrome / Matching Cap - 705401541

OUTLANDER RIM (CAMO MODEL)

• Black with clear coat aluminum rim.
G2, G2L, G2S
 Front - 12" x 6" offset = 41 mm
 705401127 - Black with clear coat
 Rear - 12" x 7.5" offset = 51 mm
 705501493 - Black with clear coat



LOCKOUT 393 14" RIM BY VISION*

• Sold individually.
 • Matching Cap (705401362), Matching Nuts (250100100).
 Front - 14" x 7"
 Bolt circle pattern: 4/136 mm
 Wheel offset: 4 + 3
 705401363

Rear - 14" x 8"
 Bolt circle pattern: 4/136 mm
 Wheel offset: 4 + 4
 705501787



RIMS

14" RIM

• Premium cast aluminum black painted with machining and clear coat rim.
 • Center hole: 72 mm
 • Bolt circle pattern: 4/136 mm

G2 DPS, G2 XT, G2 MAX 650, G2 MAX XT, G2 MAX Limited

| | |
|------------------------------------|------------------------------------|
| Front - 14" x 6.5" offset = 40 mm | Rear - 14" x 8.5" offset = 50 mm |
| 705401853 - Black and machined | 705502402 - Black and machined |
| 705401852 - Black with clear coat | 705502401 - Black with clear coat |
| 705401851 - Silver with clear coat | 705502400 - Silver with clear coat |



Note: Matching Nuts - 250100100 Black, 250100082 Chrome / Matching Cap - 705400928

12" BEADLOCK RIM

• Black with clear coat aluminum rim.
 • Needs 16 bolts (250000435) for installing the beadlock.
 • Choice of beadlock color (not included).

G2, G2L, G2S

| | |
|---------------------------------|----------------------------------|
| Front - 12" x 6" offset = 41 mm | Rear - 12" x 7.5" offset = 51 mm |
| 705401678 - Black | 705502244 - Black |

12" BEADLOCK

• Cast aluminum beadlock.
 • Must be installed on Front Rim (705401678) and Rear Rim (705502244).

G2, G2L, G2S

■ 705401763 - Can-Am Red
 ■ 705401156 - Yellow
 ■ 705401533 - Orange Crush
 ■ 705401812 - Manta Green



Note: Matching Nuts - 250100100 / Matching Cap 705400928

14" BEADLOCK RIM

• Black with clear coat aluminum rim.
 • Choice of beadlock color (not included).
 • Needs 16 bolts (250000435) for installing the beadlock.

G2

| | |
|-----------------------------------|--------------------------------|
| Front - 14" x 6.5" offset = 41 mm | Rear - 14" x 8" offset = 51 mm |
| 705401594 | 705502146 |

14" BEADLOCK

• Cast aluminum beadlock.
 • Must be installed on Front Rim (705401594) and Rear Rim (705502146).

G2

■ 705401586 - Manta Green
 ■ 705401702 - Octane Blue
 ■ 705401837 - Can-Am Red
 ■ 705401840 - Black



Note: Matching Nuts - 250100100 / Matching Cap 705400928

Some products shown may not be available or homologated in your country. Contact your BRP dealer for local details.

*Consult your operator's guide/owner's manual for proper tire type and rim sizing. Improper tire type and rim selection may affect vehicle handling. Check with your local authorities for proper regulation.

SPORTSWEAR & RIDING GEAR



**NEW ZIPPED HOODIE**

- Full-zip hooded sweatshirt.
- Ribbed waistband and cuffs.
- 60% Cotton, 40% Polyester Fleece
- Can-Am print in hood liner.
- High-density logo at front.
- 2 hand warmer pockets.
- Woven label at pockets.

454080 - S, M, L, XL, 2XL, 3XL - Blue (80), Black (90)

**NEW CAN-AM PULLOVER HOODIE**

- Lightweight cotton hoodie.
- Printed logo at sleeve.
- Woven label at hem.

60% Cotton, 40% Polyester
454079 - S, M, L, XL, 2XL, 3XL - Charcoal Grey (07)

**NEW ORIGINAL TEE**

- Cotton tee with discharge print logo and woven label at back.
- 100% Cotton

454068 - XS, S, M, L, XL, 2XL, 3XL - White (01), Black (90)

**NEW INTRUSION TEE**

- Cotton tee with screen print logo and woven label at back.
- 100% Cotton

447373 - XS, S, M, L, XL, 2XL, 3XL - Black (90), Amber (95)

**NEW X-TEAM TEE**

- Cotton tee with screen print logo at front and back.
- Woven label at side.
- 100% Cotton

454069 - XS, S, M, L, XL, 2XL, 3XL - Blue (80), Black (90)

**NEW TECHNICIAN SHIRT**

- Yarn dyed twill shirt.
- Patch logos at front.
- Pleat at center back.
- Chest pocket with zipper.

60% Cotton, 40% Polyester
454074
S, M, L, XL, 2XL, 3XL
Blue (80), Black (90)

**NEW LONG SLEEVE ORIGINAL TEE**

- Cotton tee with discharge print logo and woven label at back.
- 100% Cotton

454085
S, M, L, XL, 2XL, 3XL
White (01), Black (90)

**NEW LADIES' ORIGINAL TEE**

- Cotton tee with discharge print logo and woven label at back.
- Feminine cut.

95% Cotton, 5% Spandex
454071
XS, S, M, L, XL, 2XL
White (01), Black (90)

**NEW LADIES' X-TEAM TEE**

- Cotton tee with screenprint logo and woven label at side.
- Pocket at front.

95% Cotton, 5% Spandex
454070
XS, S, M, L, XL, 2XL
Turquoise (Aqua) (76),
Black (90)



NEW INTRUSION CAP

- Adjustable plastic strap.
- Cotton canvas at front.
- Embroidered logos at front.
- Mesh at back.

55% Cotton, 45% Polyester

447370 • One size
Charcoal Grey (07), Black (90)



NEW INTRUSION FLAT CAP

- Adjustable plastic strap.
- Cotton canvas.
- Logo embroidered at front.
- Woven label at back.
- Screen print under brim.

100% Cotton

447383 • One size
Blue (80)



NEW FLAT EDGE CAP

- Adjustable plastic strap.
- Flat peak.
- Cotton canvas at front.
- Mesh at back.

55% Cotton, 45% Polyester

447646 • One size
Black (90)



NEW CLASSIC CAP

- Adjustable plastic strap.
- Embroidered 3D logo at front.

100% Cotton

448522 • One size-Grey (09), Red (30), Blue (80), Navy (89), Black (90)

- Woven label at back.
- Screen print under brim.



NEW ADVENTURE TEAM JERSEY

- Quick-dry, antibacterial moisture-wicking fabric.
- Extended back for coverage while riding.
- Mesh fabric for extra ventilation underarms.
- Non-fading sublimated graphics.
- Rib cuffs.

100% Polyester

454072 • S, M, L, XL, 2XL, 3XL • Grey (09), Red (30)

NEW X-RACE JERSEY

- Ultralight, quick-dry, antibacterial and moisture-wicking fabric.
- Mesh fabric for maximum breathability.
- Extended back for coverage while riding.
- Non-fading sublimated graphics.
- Rib cuffs.

100% Polyester

454073 • S, M, L, XL, 2XL, 3XL • Charcoal Grey (07), Blue (80)



MUD GEAR

MUD JACKET

- 100% waterproof PVC.
- Electronically-welded seams.
- Underarm and rear vent panels.
- 2 hand pockets.

Polyvinyl Chloride (PVC)

286676 • S, M, L, XL, 2XL • Clear (00), Matte Black (93)



MUD PANTS

- Oversized pants made of 100% waterproof PVC.
- Electronically-welded seams.
- Strategically placed ventilation.
- Side openings at bottom leg.

Polyvinyl Chloride (PVC)

286128 • S, M, L, XL, 2XL • Clear (00), Matte Black (93)



NEW LADIES' TEAM JERSEY

- Semi-fitted cut specifically designed for ladies.
- Quick-dry, antibacterial, moisture-wicking fabric for maximum comfort.
- Mesh fabric for extra ventilation underarms.
- Rib cuff.
- Non-fading sublimated graphics.

90% Polyester, 10% Spandex

454134 • XS, S, M, L, XL, 2XL • Grey (09), Teal (74)



Some products shown may not be available or homologated in your country. Contact your BRP dealer for local details.



ENDURO DESIGNED FOR LONG RIDES AND HIGH ADVENTURE.

Features & Benefits

Perfect for adventure riding, on or off the trails. The EX-2 offers the dual experience of riding with a visor helmet plus the look and advantages of an MX helmet.

- Advanced plastic composite shell.
- Lockable, multi-positions and anti-scratch visor.
- Interchangeable retractable sun visor.
- Removable aerodynamic peak.
- Ultra-comfort and washable Dri-Lex⁺ linings.
- Oversized chin deflector.
- Adjustable air vents and exhausts.

EX-2 ENDURO HELMET

Shell: Polycarbonate Composite

448466

XS, S, M, L, XL, 2XL
Black with graphics (94)

DOT ECE22.05



XP-3 SUPERLIGHT CROSS-STYLE HELMET: FEATURE-PACKED FOR EXCEPTIONAL PERFORMANCE, PROTECTION AND COMFORT.

Features & Benefits

- Premium shell construction using superlight fiberglass and impact absorbing EPS liner.
- Aero-tuned fully adjustable visor system.
- Custom stainless grille design.
- Front and rear hi-max air vent system to maximize cooling.
- Removable, washable and replaceable CoolMax[™] moisture-wicking liner.
- Lightweight double-D chin strap.
- Weight: ±1470 grams for size Large.
- Durable multi-colored clear coated graphics.
- Can-Am branded.
- Triple certified: DOT, ECE and SNELL M2015.

NEW XP-3 PRO X-RACE HELMET

Shell: Fiberglass

448537

XS, S, M, L, XL, 2XL
White (01), Gold (11)

DOT Snell ECE22.05



XC-4 PREMIUM LOOK & STYLE.

Features & Benefits

- Shell construction is super light polycarbonate with impact absorbing EPS liner.
- Fully adjustable visor system.
- Custom stainless grille design.
- Front and rear hi-max air vent system to maximize cooling.
- Removable, washable and replaceable moisture-wicking liner.
- Lightweight double-D chin strap.
- Weight: ±1470 grams for size Large.

NEW XC-4 MODERN HERITAGE HELMET

- Durable multi-colored clear coated graphics.
- Can-Am branded.

Shell: Polycarbonate Composite

448526

XS, S, M, L, XL, 2XL
White (01), Grey (09)

DOT ECE22.05



XC-4 HELMET

Shell: Polycarbonate Composite

448255

XS, S, M, L, XL, 2XL
Black (90)

DOT Snell



LADIES' XC-4 HELMET

- Durable multi-colored clear coated graphics.
- Winter breath deflector included.

Shell: Polycarbonate Composite

448397

XS, S, M, L, XL, 2XL
Pink (36)

DOT ECE22.05



DUST MASKS

- Easily replaceable filters remove 99.9% of airborne dust, particles, pollen and odors.
- Made from soft yet durable neoprene material that fits snugly under helmets and goggles.
- XS/S fits most kids 12 and under, M/L fits most riders and XL/2XL fits larger frames (235+ lb).
- Includes 2 replacement filters and a small storing pouch.



NEW CAN-AM ORIGIN DUST MASK

- Convenient MP3 player pocket on the side.

448524

XS/S, M/L, XL/2XL
Black with graphics (94)



NEW CAN-AM VENTED DUST MASK

448525

XS/S, M/L, XL/2XL
Black (90)

COMMUNICATION SYSTEM

NEW SENA 30K BLUETOOTH COMM SYSTEM

- Bluetooth headset that operates on Sena's Mesh Intercom[™] technology.
- The 30K has a new quick charge feature meaning just 20 minutes of charging gets riders an impressive 5 hours of Bluetooth intercom use, or 3 hours Mesh Intercom use.
- 2.4 GHz frequency, connecting to other riders in an entirely new way.
- Should one of the group's riders go out of range, the Mesh Intercom intelligently keeps the rest of the group in seamless communication, while actively searching to reconnect, should that rider come back within range.
- Using the private group mode, the 30K can pair in full duplex communication with up to 16 riders at a range up of to 1.2 miles.
- Sena 30K Audio Multitasking technology allows you to have a conversation via Adaptive Mesh-Networking technology while simultaneously enjoying Bluetooth operations such as streaming smartphone music, taking or making phone calls, or listening to turn-by-turn GPS navigation.

Single Pack

448610

One size
Black (90)

Dual Pack

448611

One size
Black (90)



GOGGLES

CAN-AM RACE SAND GOGGLES BY SCOTT

- No Fog[®] anti-fog lens treatment.
- 100% UV protected grey Lexan[®] lens.
- Dust catcher vent foam.
- Multi-layer face foam.
- Durable anti-slip strap.
- Tear-off and roll-off compatible (sold separately).
- Extra clear lens in the box.

448491 · One size · Black (90)



CAN-AM TRAIL GOGGLES BY SCOTT

- 100% UV protected clear Lexan lens.
- Hypoallergenic super-soft face foam.
- Durable anti-slip strap.
- Tear-off and roll-off compatible (sold separately).

447899 · One size

White (01), Yellow (10), Black (90)



GLOVES

NEW X-RACE GLOVES

- Air mesh panels for ventilation and mobility.
- Double Clarino[®] layer at palm and thumb for extra durability and comfort.
- Pre-curved design.
- Silicone fingertip for better grip.
- Direct-injection details on back hand.
- Hook-and-loop wrist closure system.

Air Mesh, Spandex, Clarino[®]

MEN'S

446306

XS, S, M, L, XL, 2XL
Red (30), Blue (80)



LADIES'

446311

S, M, L, XL, 2XL
Turquoise (Aqua) (76),
Black (90)



NEW ADVENTURE TEAM GLOVES

- Spandex construction for flexibility.
- Chamude palm.
- Pre-curved design.
- Non-fading sublimated graphics.
- Slip-on gloves.
- Welded logo.
- Silicon print at inner fingers.

Shell: Spandex, Chamude, Polyester

446305 · S, M, L, XL, 2XL, 3XL
Red (30)



JUNIOR

JUNIOR X CRUSH HELMET

- Advanced Plastic Composite Shell.
- Multi-density EPS liner.
- Ultra-plush removable/washable liners.
- Adjustable visor to protect from the elements.
- Multiple air vents help keep you cool and dry.
- Lightweight double-D chin strap.
- Ski-Doo and Can-Am stickers in the box.
- Optional breath deflector (sold separately).

Shell: ABS

448506 · S, M, L · Black with graphics (94)



CAN-AM JUNIOR TRAIL GOGGLES BY SCOTT

- Integrated custom painted frame and strap graphics.
- No Fog[®] anti-fog lens treatment.
- 100% plastic UV protected clear Lexan[®] lens.
- Multi-layer face foam.
- Durable anti-slip strap.

448512 · One size · Black (90)



BAGS

CAN-AM SLAYER GEAR BAG BY OGIO

- Large main compartment with easy access to all gear.
- Large separated boot pocket.
- Zippered accessory pocket.
- Easy grab handles for transport.
- Detachable shoulder strap.
- Heavy-duty reinforced base
- Dimensions: 32" H x 16" W x 18" D (81 cm x 41 cm x 46 cm)

100% Polyester

469294 · One size · Black (90)



CAN-AM URBAN BACKPACK BY OGIO

- Airport security friendly protective laptop compartment.
- Padded iPad[™]/tablet/e-reader pocket.
- Dual side water bottle/accessory holders.
- Fully adjustable ergonomic shoulder straps.
- Front pocket with two padded accessory compartments and slip pocket.
- Dimensions: 19.5" H x 13.5" W x 9.5" D (50 cm x 34 cm x 24 cm).

100% Polyester

469293 · One size · Black (90)



SIZING CHART

HOW TO MEASURE

- For best results, have someone else take measurements.
- Measure body in underwear.
- Tape must be snug but not tight.
- If measurements fall between two sizes, order the larger size.

- HEAD** Around your head, from the center of the forehead, above the ears and over the natural bump at the back of the head.
- ARM LENGTH** Let the hands hang down on the side in a slightly bent position. Measure from the center of the back of your neck, along the length of your arm, to the wrist.
- CHEST/ BUST** Measure under your arms, around the fullest part of your chest.
- WAIST** Measure around your natural waistline, keeping one finger between the tape and body.
- HIPS** Across the fullest part of the seat.
- INSEAM** Without shoes, from crotch to the floor.

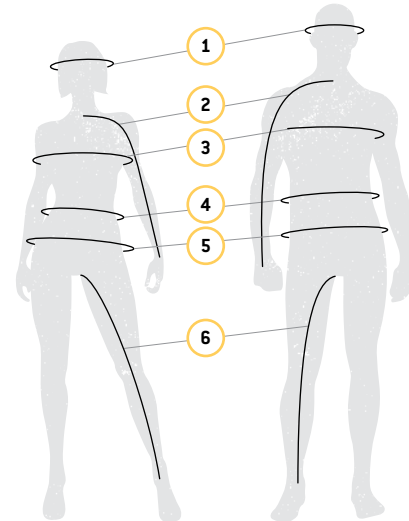

WHAT CODE REPRESENTS YOUR SIZE?

1. Find your size.

2. The corresponding code is **THE CODE** you use to complete the part number on your order.

Example: 440227__90 Size: M = Code "06", therefore 4402270690

| SIZE | CODE | SIZE | CODE | SIZE | CODE | SIZE | CODE | SIZE | CODE | SIZE | CODE |
|----------|------|------|------|-------|------|-------|------|------|------|------|------|
| One Size | 00 | XL | 12 | L/XL | 73 | 11/12 | 56 | 10 | 30 | 32 | 38 |
| XS | 02 | XLT | 13 | 2 | 21 | 13/14 | 80 | 10.5 | 99 | 34 | 39 |
| XS/S | 90 | 2XL | 14 | 3/4 | 79 | 14/16 | 50 | 11 | 31 | 36 | 40 |
| S | 04 | 3XL | 16 | 5/6 | 52 | 4 | 23 | 12 | 32 | 38 | 41 |
| M | 06 | 4XL | 18 | 6/8 | 48 | 6 | 25 | 13 | 33 | 40 | 42 |
| MT | 07 | 5XL | 88 | 7/8 | 54 | 7 | 27 | 14 | 34 | 42 | 43 |
| L | 09 | S/M | 72 | 9/10 | 55 | 8 | 28 | 28 | 36 | 44 | 44 |
| LT | 10 | M/L | 91 | 10/12 | 49 | 9 | 29 | 30 | 37 | | |

MEN'S—1.77 M - 1.83 M

| | XS | S | M | L | XL | 2XL | 3XL |
|------------|-------|--------|---------|---------|---------|---------|--------|
| CHEST | 89-94 | 94-102 | 102-112 | 112-122 | 122-132 | 132-142 | 52-56 |
| WAIST | 74-79 | 79-86 | 86-97 | 97-107 | 107-117 | 117-127 | 46-50 |
| HIPS | 89-94 | 94-102 | 102-112 | 112-122 | 122-132 | 132-142 | 52-56 |
| ARM LENGTH | 79-81 | 81-84 | 84-86 | 86-89 | 89 | 89-91 | 35 |
| INSEAM | 80-81 | 81 | 81 | 81 | 81-82 | 82-83 | 32 1/2 |

LADIES'—1.64 M - 1.77 M

| | XS | S | M | L | XL | 2XL | 3XL |
|------------|-------|-------|--------|---------|---------|---------|---------|
| CHEST | 81-86 | 86-91 | 91-99 | 99-107 | 107-114 | 114-124 | 124-134 |
| WAIST | 61-66 | 66-71 | 71-76 | 76-86 | 86-94 | 94-104 | 104-114 |
| HIPS | 86-91 | 91-97 | 97-102 | 102-112 | 112-119 | 119-132 | 132-140 |
| ARM LENGTH | 79 | 79-81 | 81 | 81-83 | 83 | 83-86 | 86 |
| INSEAM | 76 | 76 | 76 | 76 | 76 | 76-77 | 77 |

MEN'S GLOVES (MEASURE PALM WIDTH)

| | S | M | L | XL | 2XL | 3XL |
|----|-----|-----|-----|------|------|-----|
| CM | 7.5 | 8.5 | 9.5 | 10.5 | 11.5 | 14 |

LADIES' GLOVES (MEASURE PALM WIDTH)

| | S | M | L | XL | 2XL |
|----|-----|-----|-----|----|------|
| CM | 6.8 | 7.5 | 8.3 | 9 | 11.5 |

HELMETS

| | XS | S | M | L | XL | 2XL | 3XL |
|-----------|-------|-------|-------|-------|-------|-------|-------|
| HEAD (CM) | 53-54 | 55-56 | 57-58 | 59-60 | 61-62 | 65-66 | 65-66 |

JUNIOR HELMETS

| | S | M | L |
|-----------|-------|-------|-------|
| HEAD (CM) | 49-50 | 51-52 | 53-54 |

GENUINE CAN-AM PARTS

REMEMBER WHAT MADE YOU FALL FOR A CAN-AM VEHICLE?
Precisely engineered. Rigorously tested. Factory approved. The ultimate off-road experience continues with the Genuine Can-Am parts.

PARTS THAT SET THE STANDARD

2 YEARS WARRANTY ON ALL GENUINE CAN-AM PARTS



REGULAR MAINTENANCE ENSURES YOUR OUTLANDER PERFORMANCE STAYS AT ITS PEAK.

KEEP AN EYE ON THESE COMPONENTS*

- 1 OIL FILTER 420256188
- 2 ENGINE OIL SEE P.78
- 3 FUEL FILTER 709000330
- 4 AIR FILTER 707800371
- 5 CVT INTAKE FILTER 707001130
- 6 DRIVE BELTS SEE P.74
- 7 BRAKE PADS SEE P.74
- 8 BOOT KITS SEE P.74
- 9 WHEEL BEARINGS 293350118
- 10 A-ARM BUSHINGS 703500875
- 11 BALL JOINTS 706202044/706202045
- 12 SPARK PLUG 715900352/707000246
- 13 BATTERY SEE P.74

*Refer to periodic maintenance chart for proper intervals.

Some products shown may not be available or homologated in your country. Contact your BRP dealer for local details.



REGULAR MAINTENANCE ENSURES YOUR RENEGADE PERFORMANCE STAYS AT ITS PEAK.

KEEP AN EYE ON THESE COMPONENTS*

- 1 OIL FILTER 420256188
- 2 ENGINE OIL SEE P.78
- 3 FUEL FILTER 709000330
- 4 AIR FILTER 707800371
- 5 CVT INTAKE FILTER 707001786
- 6 DRIVE BELTS SEE P.74
- 7 BRAKE PADS SEE P.74
- 8 BOOT KITS SEE P.74
- 9 WHEEL BEARINGS 293350118
- 10 A-ARM BUSHINGS 703500875
- 11 BALL JOINTS 706202044/706202045
- 12 SPARK PLUG 715900352/707000246
- 13 BATTERY SEE P.74

*Refer to periodic maintenance chart for proper intervals.

GENUINE CAN-AM MAINTENANCE PARTS

OIL FILTER

420256188
420256455 • Fits DS450



O-RING (DRAIN PLUG)

(Not illustrated)
420552280

O-RING (OIL FILTER COVER)

(Not illustrated)
420230920

COMPLETE OIL CHANGE KIT ALSO AVAILABLE—SEE PAGE 80

AIR FILTERS

- Prevent airborne contaminants from reaching your engine.
- Protect internal components against premature wear.
- Genuine BRP air filters ensure absolute compatibility and a perfect fit.

707800371 - Premium Air Filter
715001333 - Performance Air Filter by Twin Air



SPARK PLUG

• Ask your authorized Can-Am dealer which one fits your vehicle.
715900352 • 500, 570, 650 Engines
707000246 • All except 500, 570, 650



FUEL FILTER

(Not illustrated)
709000330

CVT INTAKE FILTER

(Not illustrated)
701001130 • Outlander
707001786 • Renegade

SEE OIL & MAINTENANCE PRODUCTS AT PAGE 78

VISIT THE CAN-AMOFFROAD.COM PARTS & MAINTENANCE SECTION TO SEE THE FULL LINE OF GENUINE CAN-AM PARTS.

Note: Please contact your dealer or visit our online store at can-amoffroad.com for suggested retail prices regarding Genuine Can-Am Parts.

PREMIUM DRIVE BELT

- Premium drive belt calibrated to maximize your vehicle's performance.
- Aramid tensile cords used in construction for extra long life and dependability.
- Built with distinctive durability features for off-road riding.

422280360 - 500CC & more.
715900024 - 450CC & less.
715900023 - Traxter



PERFORMANCE DRIVE BELT (100% PBO)

- High-performance belt technology designed for side-by-side usage, but compatible on ATVs for most drivers.
- 100% cutting-edge PBO high-tensile strength polymer fiber construction.
- Designed for high-temperature robustness and prolonged durability.

422280364

PULLER/LOCKING TOOL / DRIVEN ADAPTOR

(Not illustrated)

- Spreads the secondary clutch open for easy belt replacement.
- Locks engine at TDC for maintenance tasks.

529036098

METALLIC BRAKE PAD KIT

- Built strong to last longer. Heavy-duty construction stands up to hard braking.
- Designed to handle demanding riding conditions with challenging braking environments such as mud and sand.
- Created specifically for use with Can-Am ATVs.

Contact your authorized dealer or visit our online store at can-amoffroad.com

705600350 - Front Right
705600349 - Front Left
705600398 - Rear Left

Outlander X mr, MAX X-TP, MAX XT, MAX PRO, MAX Limited, Renegade X xc (2012)

715900248 - Front and Rear Right
715900249 - Front Left



ORGANIC BRAKE PAD KIT

- Chosen as the standard OEM on Can-Am ATVs for dry conditions.
- Provides excellent braking capacity with optimal efficiency, a great feel, and low noise.

Contact your authorized dealer or visit our online store at can-amoffroad.com

705601014 - Front and Rear Right
705601015 - Front Left & Rear Left (Renegade only)



YUASA[®] BATTERIES

- Top of the line models from the leading preferred original equipment battery supplier in North America.

| Renegade & Outlander 2004-2012 | Traxter & Quest 1999-2006 | DS (250, 90,70,50) 18 Amps. Wet (YTX20L-BS) 410301203 |
|--------------------------------|------------------------------------|---|
| 19 Amps. Dry (YB16CL-B) | 13 Amps. Wet (YTX15L-BS) 710000283 | |



CVT GASKET COVER

(Not illustrated)

G2 (Outlander & Renegade)
420430126

G2L (Outlander & Outlander MAX 450)
420630292

G1 (Outlander & Outlander MAX 400)
420630290

PREMIUM HALF SHAFT

- Premium quality design ideal for off-road use.
- Includes CVs, Shaft and Boots with the best suited geometry for your Can-Am vehicle.

Front Left

705401429 - Engine 570 EFI
705401115 - All models (except X mr, Engine 570)

Front Right

705401428 - Engine 570 EFI
705401116 - All models (except X mr, Engine 570)

Rear Left

705501485 - All models (except X mr)

Rear Right

705501486 - All models (except X mr)



PERFORMANCE HALF SHAFT

- High-performance design ideal for off-road use with superior protection in mud riding.
- Includes CVs, Shaft and Boots with the best suited geometry for your Can-Am vehicle.

X mr models

705401704 - Front Left
705401703 - Front Right
705501848 - Rear Right
705501847 - Rear Left

WHEEL BEARINGS

(Not illustrated)

- Sealed bearings for additional protection from water and dirt.

293350118

A-ARM BUSHING KIT

- All you need to renew your suspension A-Arms. This bushing kit includes 2 bushings, a sleeve and a wearplate as illustrated.

703500875



CV BOOT KITS

- Come with clamps and grease.
- Genuine BRP CV Boot Kits ensure absolute compatibility and a perfect fit.

Front Wheel Side

715900298 - X mr
705401345 - All models (except X mr)

Front Differential Side

715900299 - X mr
705401346 - All models (except X mr)

Rear

705501864



BALL JOINTS

- Robust design for off-road usage and sealed for prolonged durability.

706202044 - Upper
706202045 - Lower



CHOOSING THE RIGHT DRIVE BELT CAN IMPACT POWER & PERFORMANCE

WHAT MAKES CAN-AM BELTS STAND OUT?

One essential material stands among our drive belt components: **PBO Fiber.**

PBO Fiber is the next generation super fiber with excellent thermal stability, great abrasion resistance, and moreover, almost twice the strength and modulus of Aramid fiber.

> We partner with the best manufacturers in the powersports industry to offer you **unique drive belts** with consistent quality.

> The **100% cutting-edge PBO high-tensile strength polymer fiber** construction offers high-temperature robustness and prolonged durability.

> Our engineering teams have perfectly integrated and tested each drive belt to **provide quick throttle response, powerful acceleration, top speed and consistent shifting performance.**

> We aim at delivering the highest levels of performance and longevity based on **your vehicle's specific end-use and calibration.**

CAN-AM BELT CONSTRUCTION VS. COMPETITORS

MODULUS & TENSILE STRENGTH

Based on Dynamometer testing, PBO surpasses Kevlar and Carbon Fiber materials in every way.

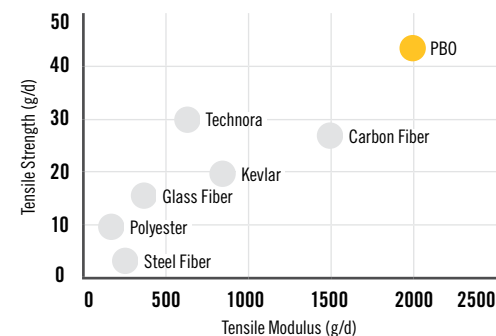

DURABILITY COMPARISON

Compared to Can-Am's Performance Drive Belt (100% PBO - 422280364).

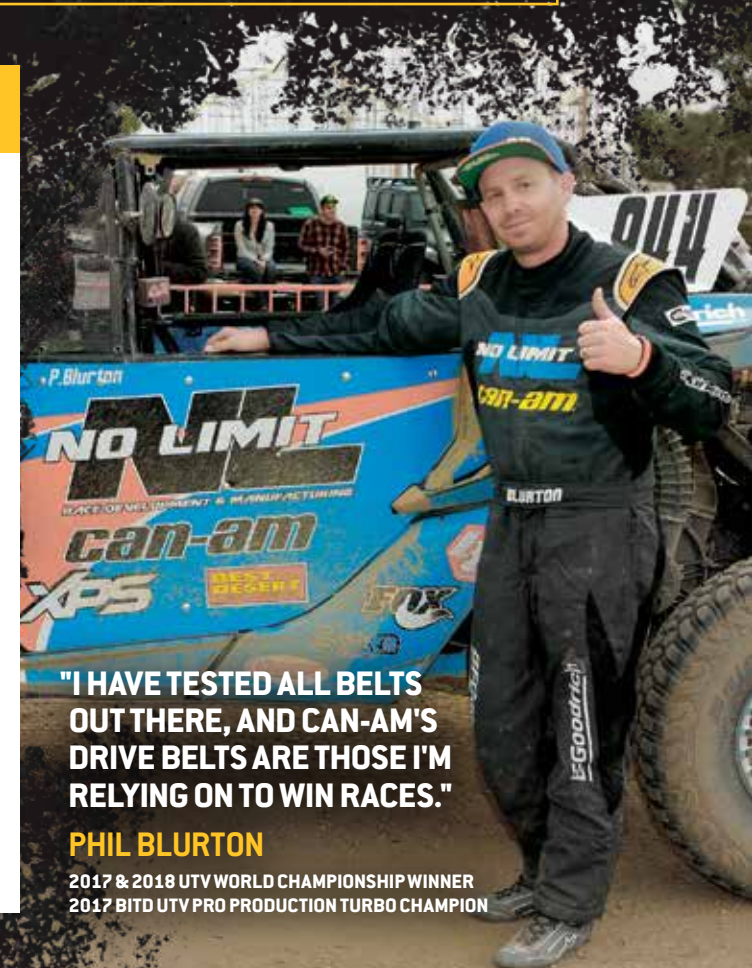
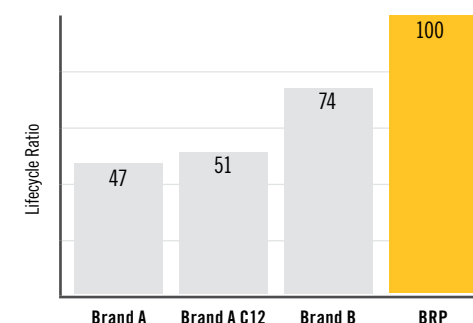

"I HAVE TESTED ALL BELTS OUT THERE, AND CAN-AM'S DRIVE BELTS ARE THOSE I'M RELYING ON TO WIN RACES."

PHIL BLURTON

2017 & 2018 UTV WORLD CHAMPIONSHIP WINNER
2017 BITD UTV PRO PRODUCTION TURBO CHAMPION

Note: Please contact your dealer or visit our online store at can-amoffroad.com for suggested retail prices regarding Genuine Can-Am Parts.

Some products shown may not be available or homologated in your country. Contact your BRP dealer for local details.



Rotax ACE triple-cylinder engine



Rotax V-twin engine



KYLE CHANEY
2017 TORC PRO MOD UTV CHAMPION



PHIL BLURTON
2017 BITD UTV PRO PRODUCTION
TURBO CHAMPION

WHY XPS OIL IS THE PERFECT FIT FOR YOUR ROTAX ENGINE?

Whether you purchased it as a necessity for transportation, or the pure exhilaration of performance, your Can-Am is an investment – get the most out of it. XPS lubricants are the only lubricants specifically engineered to do that with your Rotax-powered Can-Am vehicles.

XPS oil meets the demands of high-performance off-road engines, including turbo and supercharged engines. XPS oil is formulated specifically for the higher stress these engines experience.

UNMATCHED RELIABILITY

Get the most out of every mile on every ride.

ULTIMATE PERFORMANCE

Engineered to match the advanced performance of Rotax Engines.

MADE FOR THIS

Developed with Rotax engines to deliver the best performance and lubrication in all conditions.



XPS OIL HAS UNDERGONE RIGOROUS TESTING IN WORST CASE SCENARIOS TO PROVE ITSELF AND WILL BE USED BY MANY CAN-AM OFF-ROAD RACERS THIS YEAR.

VISIT THE CAN-AMOFFROAD.COM PARTS & MAINTENANCE SECTION TO SEE THE FULL LINE OF XPS LUBRICANTS.

XPS IS A COMPLETE RANGE OF PERFORMANCE PRODUCTS DESIGNED TO PROTECT YOUR VEHICLE AND EXTEND ITS LIFETIME.

EACH HAS BEEN RIGOROUSLY DEVELOPED, TESTED AND APPROVED. TAKE THE GUESSWORK OUT OF YOUR VEHICLE MAINTENANCE AND GET TRUE XPS PEACE OF MIND.



XPS ENGINE OILS

NEW 4T 10W-50 SYNTHETIC OIL

- Engineered for heavy-duty and high-performance 4-stroke engines, including turbocharged, supercharged and racing engines.
- Formulated using carefully selected and strenuously tested base stocks and custom additives.
- Offers thick film strength to protect bearings, and a proven high-temp detergency to minimize deposits, prevent shear, provide thermal stability, and combat fuel dilution to ensure maximum performance from your engine.

946 ml
779234
3.785 L
779235



4T 0W-40 SYNTHETIC OIL

- 4-stroke engines powering recreational vehicles through mud, snow and water withstand a lot of high RPM and high load abuse, and this full synthetic oil is carefully engineered to provide the best protection for high-performance ATVs and SSVs.
- Its wide operating temperature range, additional corrosion protection, and engineered detergency make this oil the best choice for any powersport vehicle with a 4-stroke engine used in cold weather.

946 ml
779139
3.785 L
779140



4T 5W-40 SYNTHETIC BLEND OIL

- This synthetic blend is the oil of choice for owners of high-performance vehicles with a 4-stroke engine, including turbo or supercharged engines requiring carefully engineered friction.
- Combining the finest quality synthetic base stocks with extreme-tested synthetic additives, it provides superior engine and transmission protection against rust and corrosion compared to conventional engine oils, and optimum wet clutch operation for smooth and positive shifting with better cold start protection than 10W oils.

946 ml
779133
3.785 L
779134



LUBRICANTS

SYNTHETIC GEAR OIL

- Uses custom additives to provide the best performance in Visco-Lok & Smart-Lok differentials.
- Allows higher loads, superior shear stability and reduced oxidation.
- Exceptional wear protection and superior performance at all operating temperatures.

• 946 ml
779158
75W-90

779160
75W-140



SYNTHETIC GREASE SUSPENSION

- Designed to work specifically with the components found in Can-Am vehicle suspensions.
- It is highly stable and offers optimal lubrication at both extreme cold and high temperatures while protecting suspension components from dirt and moisture, as well as corrosion under extreme washout conditions.

• 400 g
779163



ANTI-CORROSIVE LUBRICANT

- Multipurpose lubricant that can also be used to prevent rust, corrosion and moisture intrusion.
- It contains extreme pressure additives that work as an all-around lubricant for just about anywhere lubrication is needed.

• 340 g
779168



EXTENDED LIFE PRE-MIXED COOLANT

- XPS Antifreeze/Coolant contains the correct dilution and the necessary additives to prevent corrosion and inhibit cavitation in BRP cooling systems.
- Long-life, 5-year formula specially formulated for BRP vehicles.
- Superior heat transfer.
- Ideal replacement for vehicles that normally use a 2-year antifreeze/coolant (green), 5-year (orange).

• 946 ml
779150



Note: Please contact your dealer or visit our online store at can-amoffroad.com for suggested retail prices of XPS products. Some products shown may not be available or homologated in your country. Contact your BRP dealer for local details.

Note: Please contact your dealer or visit our online store at can-amoffroad.com for suggested retail prices of XPS products.

XPS MAINTENANCE PRODUCTS

DOT4 BRAKE FLUID

- Meets or exceeds all DOT3 and DOT4 brake fluid requirements.
- High-temperature formula resists fade, and also conditions seals and o-rings in braking system.
- 355 ml

779151



RACING BRAKE FLUID

- Exceeds DOT4 brake fluid requirements for extreme conditions and competition use.
- Extreme, 579-degree boiling point temperature is ideal for high-demand competition conditions to combat brake fade.
- 355 ml

779152



ENGINE OIL CHANGE KIT

- Ultra-convenient "all-in-one" oil change kit saves time and money.
- Includes XPS Synthetic or Synthetic Blend Oil, oil filter, o-rings and washer.

- 779256 • Synthetic Blend (5W-40 450 CC or less) 779252 • Full Synthetic (10W-50 500 CC or more)
- 779257 • Full Synthetic (0W-40 450 CC or less) 779260 • Synthetic Blend (5W-40 900 ACE)
- 779258 • Synthetic Blend (5W-40 500 CC or more) 779261 • Full Synthetic (10W-50 900 ACE)
- 779259 • Full Synthetic (0W-40 500 CC or more)



HIGH PERFORMANCE SUSPENSION FLUID

- A synthetic, fade-free formula for servicing FOX® shocks.
- Specially formulated for high-demand or racing application.
- Ultra high VI shock oil.
- Engineered viscosity for optimized performance with FOX® shocks valving.
- 946 ml

779153



CARBON FREE FUEL TREATMENT

- Combination of a fuel treatment and a fuel system cleaner that can be used periodically to restore lost starting or throttle performance, as well as maintain fuel system integrity and keep internal engine parts clean.
- It treats fuel for storage and addresses the moisture problems inherent in today's Ethanol-blended fuels, keeping ferrous and soft metal parts clean and free of corrosion.
- Uses patented, state-of-the-art additives.
- Cleans valves, sticky rings and combustion chamber.
- 355 ml

779169



FUEL TREATMENT CARBURETOR CLEANER

- Complete fuel treatment specially formulated to prevent small engine problems caused by Ethanol-blended fuels.
- It removes fuel system gum and varnish that may have accumulated during storage, stabilizes fuel against breakdown for 12 months or more, and adds corrosion protection from moisture for short- and long-term storage.
- It also helps restore throttle response and easy starting.
- It can be used periodically to maintain fuel system integrity, keep carburetor jets clean, and also combat moisture problems caused by Ethanol-blended fuels to keep ferrous and soft metal parts clean and free of corrosion.
- 355 ml

779172



FUEL STABILIZER

- Ethanol-compatible and will stabilize fuel in your tank to keep it from breaking down and causing hard starting, throttle hesitation and poor run quality.
- Ethanol attracts moisture, and this product contains powerful anti-corrosion additives to protect fuel system components.
- Prevents problems associated with E10 fuels.
- 236 ml

779171



XPS CLEANERS

SPRAY CLEANER & POLISH

- Removes dirt, grease, road grime and water marks easily and quickly.
- Non petroleum based formula will not harm plastic finishes.
- 340 g

219702844



BRAKES & PARTS CLEANER

- A concentrated blend of solvents with a powerful blasting spray that effectively removes grease, grime, brake fluid and other contaminants from brake components and metal parts without the need for disassembly.
- Evaporates instantly and completely, leaving no residue to hinder performance.
- Contains no ozone depleters.
- 397 g

219701776



OFF-ROAD VEHICLE WASH

- A biodegradable non-toxic cleaner that removes mud and dried-on dirt from your off-road vehicle.
- Whether grimy from the track, the woods or the fields, this cleaner will leave your off-road vehicle sparkling.
- When used as directed, XPS Wash is safe for all off-road vehicle finishes.
- 946 ml

219701702



MICROFIBER TOWELS

- The latest in high-quality detailing towels.
- Made up of extremely fine fibers, their soft surfaces have been perfected for drying and polishing painted, gel coated and hard shiny surfaces.
- They are so absorbent they hold up to seven times their weight in water.
- Machine washable means they can be used over and over again.
- Pack of 2.

219701759

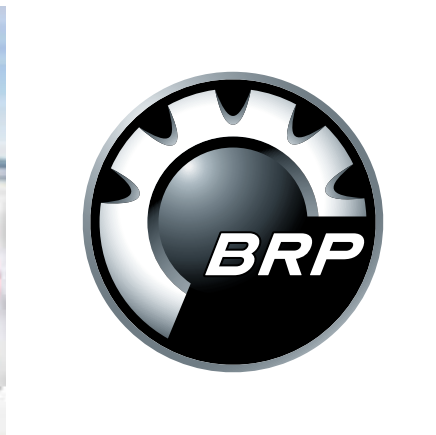

ski-doo. LYNX. SEA-DOO. EVINRUDE. ROTAX. Can-am.

Note: Please contact your dealer or visit our online store at can-amoffroad.com for suggested retail prices of XPS products.

Some products shown may not be available or homologated in your country. Contact your BRP dealer for local details.